

iSpeed3 Control Unit

iSpeed3

OPERATION MANUAL

OM-K0613E 001



CONTENTS

IMPORTANT INSTRUCTIONS AND WARNINGS-Electric Device	P1	11. CHANGING TOOLS	P12
1. CAUTION FOR HANDLING AND OPERATION	P3	12. REPLACING THE COLLET CHUCK	P12
2. FEATURES	P4	13. INSTALLATION OF THE MOTOR SPINDLE	P13
3. SPECIFICATIONS	P5	14. MOTOR CURRENT DISPLAY AND ADJUSTING THE CLAMPING PRESSURE	P14
4. SYSTEM CHART	P6	15. AIR HOSE CONNECTION AND AIR PRESSURE SETTINGS	P15
5. TORQUE CHARACTERISTICS	P7	16. BREAK-IN PROCEDURE	P16
6. NOMENCLATURE	P7	17. OPERATION PROCEDURE	P16
7. CHANGING FUSES	P9	18. EXTERNAL INPUT/OUTPUT CONTROL SIGNAL SPECIFICATIONS	P17
8. BRACKET INSTALLATION	P10	19. PROTECT FUNCTION	P26
9. POWER CORD CONNECTION	P11	20. SETTING OF OPERATING PARAMETERS	P29
10. MOTOR CORD CONNECTION	P11	21. TROUBLESHOOTING	P37

IMPORTANT INSTRUCTIONS AND WARNINGS -Electric Device

WARNING!

When using electric tools, basic safety precautions should always be followed to reduce the risk of fire, electrical shock and personal injury.

Read all these instructions before operating this product and save these instructions.

A. GROUNDING INSTRUCTIONS

1. In the event of malfunction or breakdown, grounding provides a path of least resistance for electric current to reduce the risk of electric shock. This tool is equipped with an electric cord with grounding conductor and a grounding plug. The plug must be plugged into a matching outlet that is properly installed and grounded in accordance with all local codes and ordinances.
2. Do not modify the plug provided if does not fit the outlet. A qualified electrician must install the proper outlet.
3. Improper connection of the grounding conductor can result in electric shock. The grounding conductor has an outer insulation that is green with or without yellow stripes.
If repair or replacement of the electric cord or plug is necessary, do not connect the grounding conductor to a live terminal.
4. Check with a qualified electrician or service person if the grounding instructions are not completely understood, or if in doubt as to whether the tool is properly grounded.
5. Use only 3-wire extension cords that have 3-prong grounding plugs and 3-pole receptacles that accept the power cord's plug.
6. Repair or replace a damaged or worn cord immediately.
7. This tool must be used on a circuit that has an outlet that looks like the one illustrated in sketch A in figure (see below).
8. Install an over current protective device with a maximum of 10 Amps on the control units main power circuit.
9. **USE A PROPER EXTENSION CORD.** Make sure your extension cord is in good condition. When using an extension cord, be sure to use one heavy enough to carry the current your product will draw.
An undersized cord will cause a drop the line voltage resulting in loss of power and overheating.

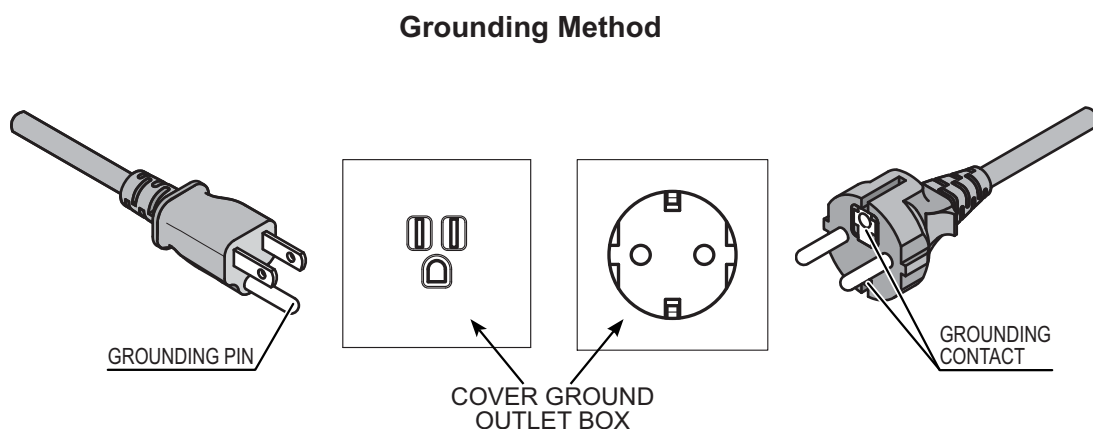

B. OTHER WARNING INSTRUCTIONS

1. For your own safety read instruction manual before operating this tool.
2. Replace cracked collet chuck or chuck nut immediately.
3. Always use guards and eye shields.
4. Do not over-tighten the chuck nut.
5. Use only NAKANISHI manufactured arbors for grinding and sawing applications.
6. REMOVE ADJUSTING KEYS AND WRENCHES. Always check to see that keys and adjusting wrenches are removed from tool before turning the unit on.
7. KEEP WORK AREA CLEAN. Cluttered areas and benches invite accidents.
8. DO NOT USE IN DANGEROUS ENVIRONMENTS. Do not use power tools in damp or wet locations, or expose them to rain.
9. Keep the work area well lighted.
10. There is a risk of injury due to accidental starting. Do not use in an area where children may be present.
11. DO NOT FORCE THE TOOL. It will do the job better and safer at the rate for which it was designed.
12. USE THE COLLECT TOOL. Do not force tools or attachments to do a job for which it was not designed.
13. WEAR PROPER APPAREL. Do not wear loose clothing, gloves, neck ties, rings, bracelets, or other jewelry that might get caught in moving parts. Nonslip footwear is recommended. Wear protective hair covering to contain long hair.
14. ALWAYS USE SAFETY GLASSES. Everyday eyeglasses only have impact resistant lenses, they are not safety glasses. Also use face or dust mask if the cutting operation is dusty.
15. SECURE YOUR WORK. Use clamps or a vise to hold work at all times.
16. MAINTAIN TOOLS WITH CARE. Keep tool sharp and clean for best performance and to reduce the risk of injury. Follow instructions for changing accessories.
17. Rotate motor spindle in a low speed and increase speed gradually for safety, before operate.
18. DISCONNECT TOOLS before servicing or when changing accessories, such as blades, cutters etc.
19. REDUCE THE RISK OR UNINTENTIONAL STARTING. Make sure main power button is in off position before plugging in. For recommended operating speed for various applications, please follow the instructions of the cutting tool manufacturers.

Thank you for purchasing the Ultra-Precision, High-Speed Motor Spindle System, iSpeed3. The iSpeed3 System was designed for use on CNC lathes and mills, robots, NC lathes and special purpose machines. This system utilizes air to cool the Motor and purge the Spindle. Please use a NAKANISHI air line kit to ensure that clean, dry, properly regulated air is supplied to the motor spindle. Please read this Operation Manual and Motor Spindle Operation Manual<OM-K0614E> carefully prior to use.

1. CAUTION FOR HANDLING AND OPERATION

- Read these cautions carefully and only use the iSpeed3 in its intended manner.
- Warnings and cautions are intended to avoid potential hazards that could result in personal injury or damage to the device. These are classified as follows in accordance with the seriousness of risk.

Class	Degree of Risk
⚠ WARNING	A hazard that could result in body injury or damage to the device if the safety instructions are not followed.
⚠ CAUTION	A hazard that could result in light or moderate bodily injury or damage to the device if the safety instructions are not followed.

⚠ WARNING

1. The iSpeed3 is not a hand tool. It is designed to be used on CNC machines or special purpose machines.
2. In the event of a malfunction or breakdown, grounding provides a path of least resistance for electric current, reducing the risk of electric shock. This system is equipped with an electric cord with a grounding conductor and grounding plug. The plug must be plugged into a matching outlet that is properly installed and grounded in accordance with all local codes and ordinances.
3. Do not use in dangerous environments. Protect the control unit from moisture and other contaminants. Failure to protect the control unit can result in damage to internal components and injury to the operator.
4. Always wear safety glasses. Everyday eyeglasses only have impact resistant lenses, they ARE NOT safety glasses.
5. Never touch the motor spindle or cutting tool while the motor spindle is rotating.
6. Reduce the risk of unintentional starting. Make sure the main power button is in the Off position before connecting the control unit or plugging the system in.
7. Do not apply excessive force. This may cause collet chuck or chuck nut, tool slippage or tool damage.
8. Do not exceed the maximum allowable tool speed. For your safety, use tools below the maximum allowable speed as set by the tool manufacturer.
9. Do not use a bent, broken, chipped, out of round or sub-standard tool. They can shatter or explode, and may cause injury.
10. Check to ensure that the supply voltage is the same as the control unit's rated voltage.
11. Never touch the power cord with wet hands. This may cause an electric shock.
12. Please make sure to use a power supply cord set which conforms to regulations/laws of the country in use and which has voltage and current ratings according to product specifications.

⚠ CAUTION

1. The motor cooling and spindle purge air is required to operate the system. The input air line must be connected to the AIR IN connector on the rear of the control unit. Air pressure between 0.2MPa-0.5MPa must be supplied.
2. Do not disassemble, modify or attempt to repair the control unit or motor spindle as it will damage internal components. There are no user serviceable parts available.
3. When an error occurs and the error lamp flashes, check and correct the cause of the malfunction before continuing use. Failure to correct the problem will result in damage to the control unit and motor spindle.

4. When the warning lamp on the control unit lights, conditions exist that could result in dangerous operation. Check operating conditions and continue to use only after correcting the problem.
5. Do not hit, drop or subject the motor spindle or control unit to shock. This will cause damage to internal components and result in malfunctions.
6. The electric motor spindle requires air for cooling and purging. Ensure that this air supply is clean and dry. Introduction of dust, moisture and other contaminants into the motor spindle will cause damage to the internal components.
7. When using control unit continuously, refer to continuous area on torque Characteristics Graph and check LOAD meter for maximum output (3 Green Lamps).
8. Do not place anything on top of the control unit.
9. Do not install the system next to RF noise sources, as malfunctions can occur. If smoke, noise or strange odors emanate from the control unit or motor spindles, immediately turn OFF the Main Power Switch, disconnect and send to a NAKANISHI dealer for evaluation.
10. Stop working immediately when abnormal rotation or unusual vibration are observed.
11. Check the tool shank and collet chuck prior to use to ensure they are clean and free of debris. The introduction of foreign particles or metal chips in to the collet chuck or spindle can cause damage and loss of precision.
12. Do not over tighten the collet chuck. This may cause spindle or collet chuck damage.
13. Use only tools with shank diameters within the tolerance of the selected collet chuck.
14. Select suitable products or tools for the applications. Do not exceed the capabilities of the motor spindle or cutting tools.
15. Check if tools, collet chucks or chuck nut are damaged before attempting to operate.
16. Make sure that the collet chuck is properly tightened. The tool may be ejected during rotation resulting in injury.
17. Attach the provided connector covers when not using Input/Output connector A/B.
18. Rotate motor spindle at a low speed and increase speed gradually for safety, before operating at normal speed.

2. FEATURES

- (1) The iSpeed3 is a system that provides a maximum output (Machine shaft output) of 150W, consisting of a compact Control Unit, Motor Spindle and Motor Cord.
- (2) The accurate rotational speed control, interfacing with external machine controls, protection functions, input/output signals and an emergency stop function allow the iSpeed3 Control Unit to establish a safe spindle system with a variety of controllable features. The control enclosure is designed to prevent debris/dust and splattered oil/water from entering it.
- (3) The Control Unit offers a wide range of rotation speeds ($1,000 \sim 60,000\text{min}^{-1}$: MAX. $80,000\text{min}^{-1}$), and the 3 digit display allows you to set the speed in 100min^{-1} increments.
- (4) 2 Motor Spindles can be connected to the control unit, switchable manually or by machine M-function.
- (5) Equipped with a Motor Current Display Function, clamping pressure can be monitored during motor/spindle installation. A Key Hold Function is also equipped to prevent erroneous operation by touching the control panel.

3. SPECIFICATIONS

3-1 Compatibility

The iSpeed3 control unit is compatible with the following overseas safety standards.

- Safety standard in North America (UL, CSA)
UL508C CSA A22.2 No.14-05
- EC Directive
Low Voltage Directive IEC/EN61800-5-1
EMC Directive EMS : EN61000-6-2
EMI : EN61000-6-4



3-2 Specifications

Model	NE273-10	NE273-12	NE273-20	NE273-23
Input	AC 100V/1.3A 50/60 Hz	AC 120V/1.1A 50/60 Hz	AC 200V/0.65A 50/60 Hz	AC 230V/0.55A 50/60 Hz
Over Voltage Category	II			
Operating temperature	0 - 40°C			
Ambient Humidity	MAX. 85%			
Speed Range	1,000 - 80,000min ⁻¹ (BM319/BM319F/BM319FC, BM320/BM320F)			
	1,000 - 60,000min ⁻¹ (BM322/BM322FR/BM322FL, BM325)			
Control Signal	Input : Digital 9 (Photo Coupler) Analog 2			
	Output : MOS Relay 9, Photo Coupler 1 Analog 3			
Protection Function	Excess Current, Trouble with the internal Power Supply, Motor Cord Disconnect, Control Unit Overheat, Brake Circuit Trouble, No Speed Signal, Low Air Pressure, Torque Over Load, External Control Signal Error, Incompatible Motor, Over Speed, Emergency Stop Signal, Emergency Stop Error, Internal Memory Error, Over Air Pressure			
Pollution Degree	2			
Weight	3.5kg			
Dimensions	W : 142mm D : 234mm H : 72mm			
Transportation and storage environment	Temperature	-10 - 60 °C		
	Humidity	10 - 85 %		
	Atmospheric pressure	500 - 1060 hPa		
Height above Sea Level	Less than 2000 m			

3-3 Standard Equipment

Model	Standard Equipment • Accessories			
NE273	• Power Cord	1pc.	• Air Hose with Filter	1pc.
	• Input/Output Connector A cover	1pc.	• Mounting Bracket	2pcs.
	• Input/Output Connector B cover	1pc.	• Power Cord Hook	1pc.
	• Plate Nut	4pcs.	• Air Branching Joint	1pc.
	• M3 Screw	4pcs.	• Air Hose (95mm) for Air Branching Joint	1pc.
	• Fuse	2pcs.	• Warning/Error Code Sheet	1sheet.
	• Motor No.1 Connector Cap	1pc.	• Operation Manual	1set.
	• Motor No.2 Connector Cap	1pc.		

3-4 Diagrams

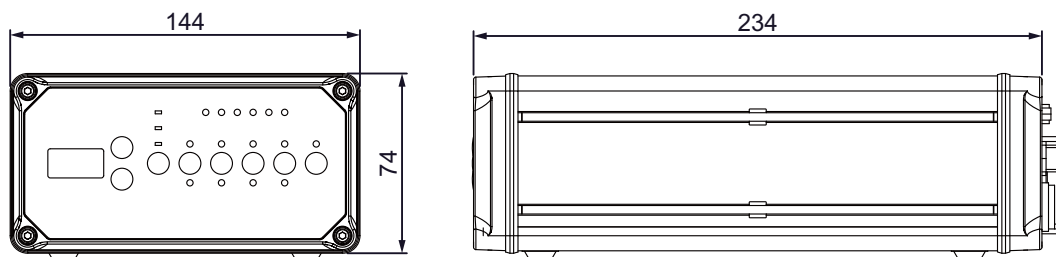

Fig. 1

4. SYSTEM CHART

Brushless Motor Spindle

80,000min⁻¹ BM319

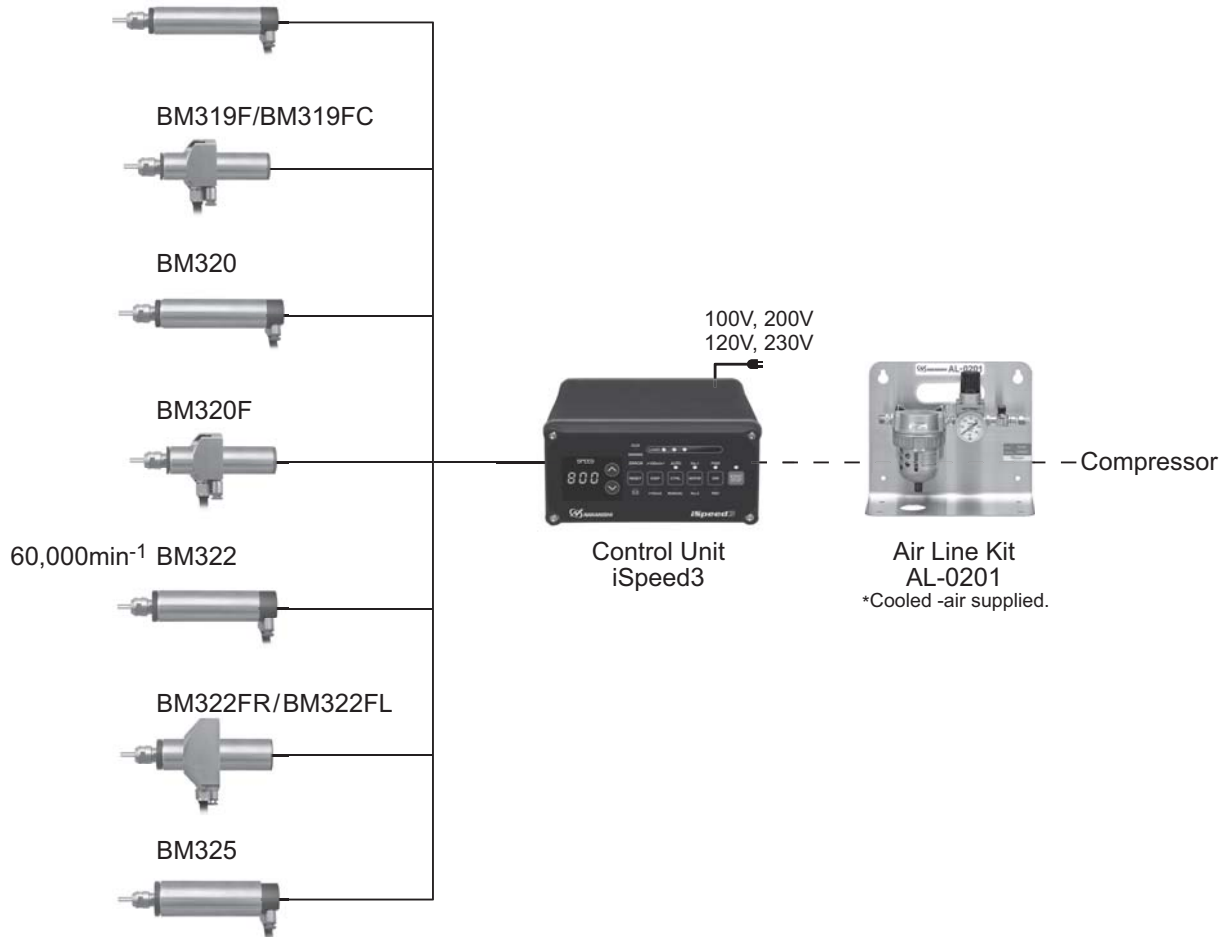
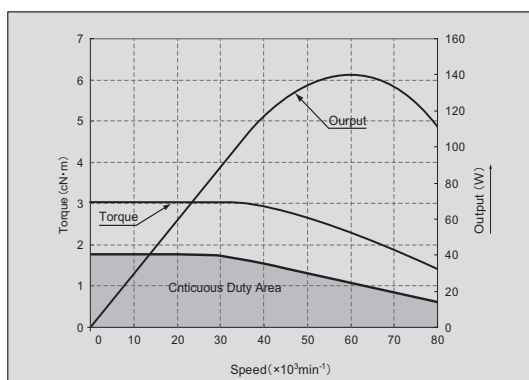

Fig. 2

5. TORQUE CHARACTERISTICS

5-1 Motor Speed 80,000min⁻¹



BM319/BM319F/BM319FC, BM320/BM320F

Fig. 3

5-2 Motor Speed 60,000min⁻¹

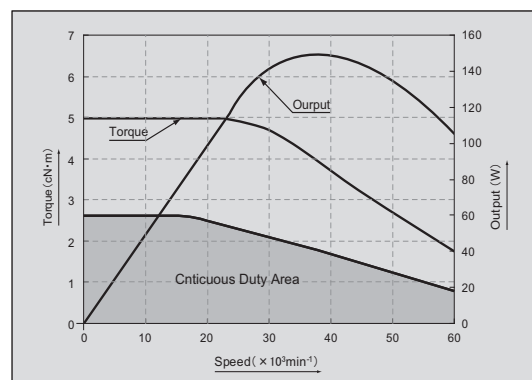

BM322/BM322FR/BM322FL, BM325

Fig. 4

6. NOMENCLATURE

6-1 Front face details



Fig. 5

① Control Unit (iSpeed3)

② Control Panel

③ Digital Speed Indicator (SPEED)

Preset Speed, Actual Speed, Warning and Error Codes are displayed (3 digit). When the motor spindle is stopped, the Preset Speed is displayed. When the motor spindle is rotating, the actual speed is displayed. This display also shows the Error Codes when an error has occurred.

④ Load Monitor LED (LOAD)

The Motor Spindle load is displayed using 6 LED's (3 Green, 2 Yellow, and 1 Red). The amount of load during rotation is displayed using the 6 LED's. Motor Spindle can only be run for a short time in Yellow range. Please refer to section 17 " PROTECT FUNCTION " of this manual for allowable duration of high load operations. When any of the Yellow or Red LED's are lit, Warning LED ⑬ will flash. If this condition is continued beyond the allowable interval the Error LED ⑫ will flash and the motor spindle will stop to protect the system.

⑤ Motor Speed Adjustment Button < ▲ (UP), ▼ (DOWN) >

Manual adjustable speed control is possible. Pushing the ▲ (UP Arrow) button will increase motor speed, pushing the ▼ (DOWN Arrow) button will decrease the speed. (1 digit is 100min⁻¹)

- Speed Range : 1,000 - 60,000min⁻¹ and 1,000 - 80,000min⁻¹
- 1,000 - 80,000min⁻¹ (BM319/BM319F/BM319FC, BM320/BM320F)
- 1,000 - 60,000min⁻¹ (BM322/BM322FR/BM322FL, BM325)

⑥ Start/Stop Button

Start and stops Motor Spindle rotation.

⑦ DIRECTION (DIR) Button

Right hand rotation (FWD.) and left hand rotation (REV.) are viewed from the cutting tool facing the operator. With the cutting tool facing the operator right hand rotation (FWD.) will be clockwise rotation.

⑧ Motor Spindle Selection (MOTOR) Button

Select the motor spindle to be controlled, either motor spindle No. 1 or No .2.

If motor spindle No. 1 was selected, No 1 LED ⑯ turns on.

⑨ CONTROL (CTRL) Button

This button selects motor spindle control from the iSpeed3 control panel or from an external source.

Manual : iSpeed3 Control panel Auto : External control through the Input/Output Connector A/B (CNC Control).

⑩ DISPLAY (DISP) Button

Select the Motor Speed Indication or Motor Current Indication.

- x 100min⁻¹ LED ⑰ lights : Motor Speed Indication.
- x 10mA LED ⑱ lights : Motor Current Indication.

⑪ RESET (RESET) Button

This button resets and allows restarting of the motor spindle after an error has been corrected.

Some Error Codes will not allow the unit to be RESET until the control Main Power Switch has been cycled.

⑫ ERROR LED (ERROR)

When a serious problem with the system is detected this LED will illuminate, the Motor Spindle is stopped and the Digital Speed Indicator ③ displays the Error Code.

⑬ WARNING LED (WARNING)

The operating and working condition of the system are constantly monitored. When an improper condition is detected, the Warning LED blinks and the Digital Speed Indicator ③ alternates between the Warning Code and the actual or preset speed, depending on whether or not the motor spindle is rotating.

⑭ RUN LED

When the motor is rotating this LED will flash.

⑮ KEY HOLD Button ()

Please hold the Reset Button ⑪ for (1 to 2 seconds). This disables all button functions.

If Key Hold is activated, displayed Dot () in Digital Speed Indicator ③ is displayed.

When releasing Key Hold, push and hold the Reset Button ⑪ down for 1-2 seconds.

6-2 Rear face details

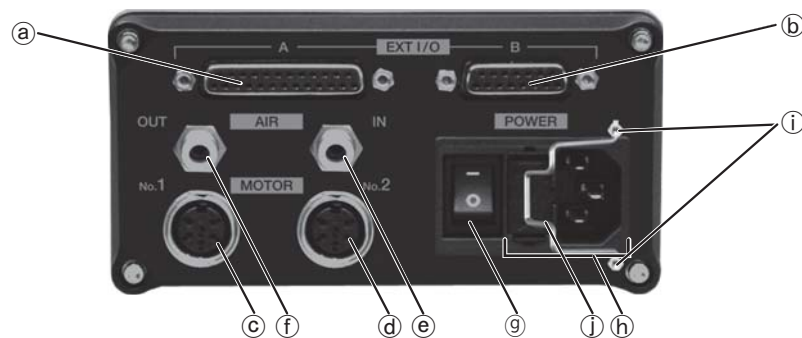

Fig. 6

① Input/Output Connector A (D-Sub 25 Connector)

Input/Output Connector A is for automatic control and monitoring of motor spindle system. When not in use please install the connector cover to prevent damage or contamination to the connector or pins.

② Input/Output Connector B (D-Sub 15 Connector)

Input/Output Connector B for automatic monitoring of emergency conditions. When not in use please install the connector cover to prevent damage or contamination to the connector or pins.

③ Motor connector No. 1

Motor connector for Motor No. 1.

④ Motor connector No. 2

Motor connector for Motor No. 2.

⑤ Air Input Joint (Hose diameter : $\phi 6\text{mm}$)

Supply air to cool and purge the motor spindle. Use clean dry air adjusted at 0.2 to 0.5MPa from the AL-0201 Air Line Kit.

When using the motor spindle, supply regulated air to control unit and set the air pressure, referring to Section 15-2 "Setting Air Supply". The air consumption is 30N ℓ /min when supplying air pressure of 0.2 - 0.5 MPa.

⑥ Air Output Joint (Hose diameter : $\phi 4\text{mm}$)

Connect air hose to supply clean, dry, regulated air for motor cooling and purging. In order to connect two motor spindles to the control unit, connect $\phi 4\text{mm}$ air hose (95mm) to air output joint on the rear of the control unit and branch the air by using the air branching joint.

⑦ Main Power Switch

⑧ Main Power Inlet : Insert the plug of the power cord. The control contains 2 fuses. When replacing the fuse, please use the specified fuse.

⑨ Fixing Power Cord Hook Bar

⑩ Power Cord Hook

(Refer to Section 9 "POWER CORD CONNECTION" to secure.)

7. CHANGING FUSES

WARNING

- Before removing fuses make sure that the Main Power Switch ⑨ is turned OFF and the power cord is disconnected from the power supply.
- Make sure and use only the properly rated and type of fuse.
- Failure to use the proper type and rated fuse will result in fire, injury, electric shock and/or product damage.

- (1) Push on the clips on the top and bottom of the fuse holder and remove the fuse folder and fuses.
- (2) Remove the bad fuse or fuses and replace with the proper type and rating of fuse as listed below and as determined by the input voltage being used.
Specified fuse : T4.0AH (100V,120V) Part No. S505-4-R (Cooper Bussmann Inc.)
T2.0AH (200V,230V) Part No. S505-2-R (Cooper Bussmann Inc.)
- (3) Replace the fuse holder containing the fuses into the Fuse Inlet Box and make sure it snaps in place.



Fig. 7

8. BRACKET INSTALLATION

⚠ CAUTION

If there is a possibility for the Control Unit to fall from its intended location. Be sure to install the provided Mounting Brackets for safety.

- (1) Mounting Brackets (2pcs.) and Plate Nuts (4pcs.) are provided with the iSpeed3 System.
- (2) The Mounting Bracket can be installed on the bottom, on the top surface and on the front side of the Control Unit.
- (3) After installing the Mounting Bracket you can use the Screw cutouts to mount the Control Unit.
- (4) Insert the Plate Nut into the groove portion of the front side of the Control Unit.
- (5) Attach the Mounting Brackets (2pcs.) using the provided Screws (4pcs.) and Plate Nuts (4pcs.).

8-1 Bottom Mounting

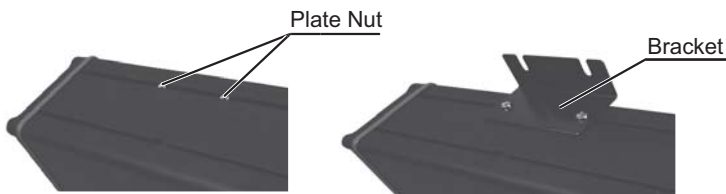

Fig. 8

Fig.9

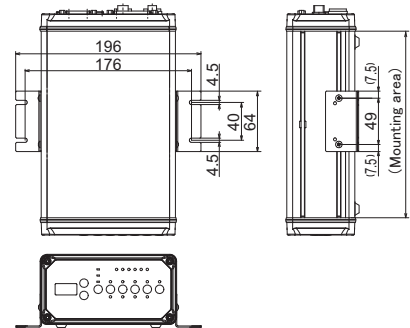

Fig. 10 Bottom Mounting

8-2 Top surface Mounting

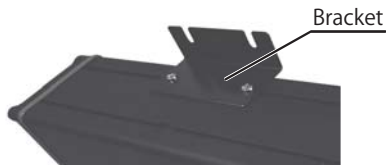

Fig.11

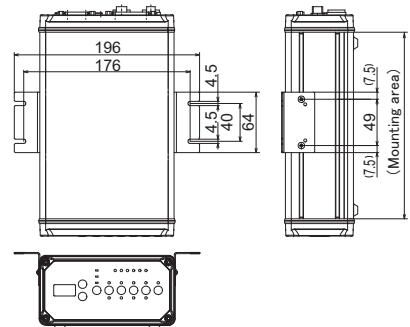

Fig. 12 Top Surface Mounting

8-3 Front side Mounting



Fig. 13

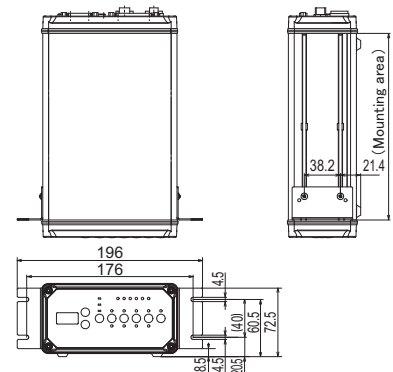

Fig. 14 Front Side Mounting

9. POWER CORD CONNECTION

⚠ WARNING

Only use grounded power sources. Failure to properly ground the control unit may result in electric shock, injury, fire and/or damage to the system components.

When connecting the power cord, make sure the Main Power Switch is turned OFF.

⚠ CAUTION

When installing the product, provide space of approximately 10cm around the control unit for easy access to the Air Inlet and the Power Cord.

- (1) Insert the power cord hook to the fixing power cord hook bar on the rear of the control unit. Refer to the Fig. 15.
- (2) Insert the female plug into the main power inlet box on the rear of the control unit. Refer to the Fig 16.
- (3) Secure the power cord by use of power cord hook. (Refer to Fig. 17.)

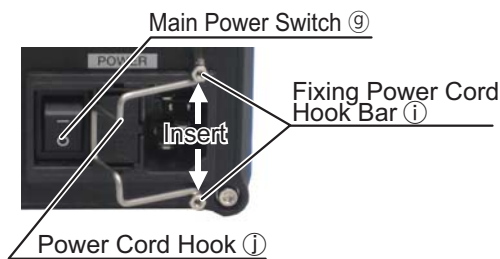

Fig. 15

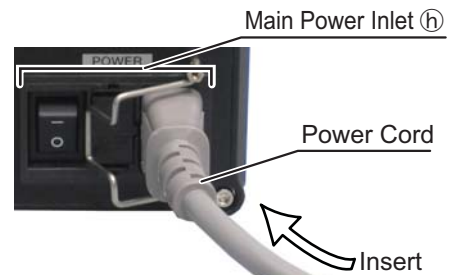

Fig. 16



Fig. 17

10. MOTOR CORD CONNECTION

⚠ CAUTION

Before connecting the motor cord, make sure the power source and control Main Power Switch ⑨ are turned OFF.

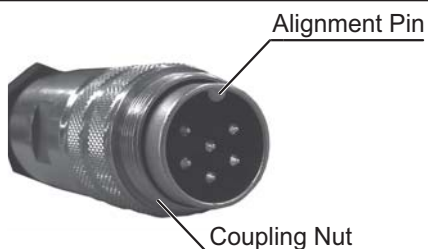

Fig. 18

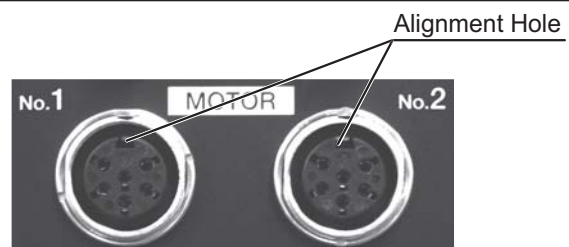

Fig. 19

- (1) Ensure alignment pin upward.
- (2) Carefully insert the alignment pin into the alignment hole and push straight into the motor lead port of the rear of the control unit.
- (3) Tighten the coupling nut.

11. CHANGING TOOLS

⚠ CAUTION

Do not tighten the collet chuck without inserting a cutting tool or dummy bur, as this will damage the collet chuck, spindle or chuck nut, causing difficulty remove the collet chuck.

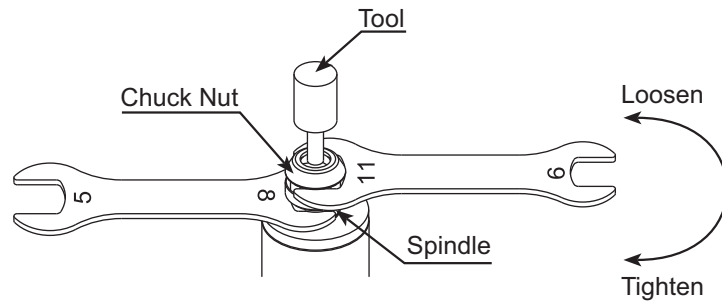

Fig. 20

- (1) Set the provided wrench (5x8) on the Spindle.
- (2) Place the provided wrench (9x11) on the chuck nut and turn it counterclockwise to loosen the collet chuck and remove the tool. (The first turn will loosen the chuck nut, but the tool will not release and turning will become stiff. Keep turning through the stiffness and the collet chuck will open.)
- (3) Clean the collet chuck and chuck nut, then insert the new tool and tighten the collet chuck by turning clockwise. Do not over tighten.

12. REPLACING THE COLLET CHUCK

- (1) Remove the tool according to the section 11 "CHANGING TOOLS" procedure above and remove chuck nut assembly. (Fig. 21)
- (2) The collet chuck and chuck nut are held together by a groove in the collet chuck and a frange in the chuck nut. To remove the collet chuck, hold the chuck nut in one hand and push diagonally down on the collet chuck. The collet chuck should be released (Fig. 22).
- (3) Install the new collet chuck in the chuck nut by positioning the collet chuck in the chuck nut and pressing down on a flat surface. (Fig. 22)

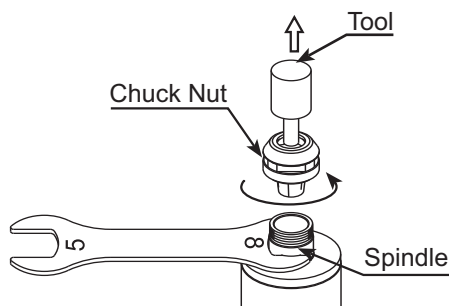

Fig. 21

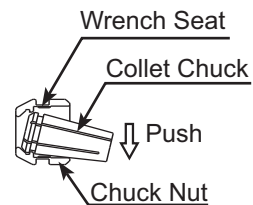

Fig. 22

13. INSTALLATION OF THE MOTOR SPINDLE

⚠ WARNING

When installing a motor spindle to a fixed base, make sure the fixed base is grounded in order to avoid the risk of an electric shock.

13-1 Fixturing a straight type motor spindle : BM319, BM320, BM322 and BM325.

(1) When mounting motor spindle, refer to the clamping area etched on the spindle body (Fig. 23).



Fig. 23

(2) The installation shown in Fig.24 is the recommended fixturing method. If this is not possible, install as shown in Fig. 25. Do not use Set Screws directly in contact with the motor spindle body as shown in Fig. 26, as this will result in damage to the motor spindle housing and internal components. When mounting, never clamp directly over the bearings, as this will result in bearing damage.

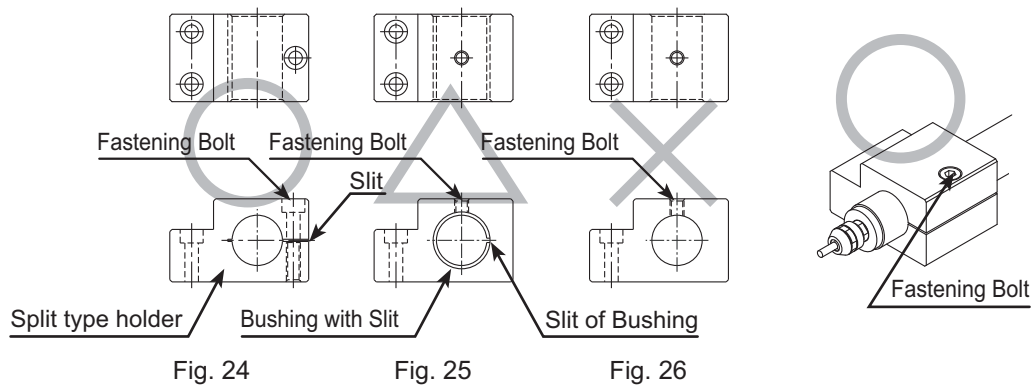

Fig. 24

Fig. 25

Fig. 26

⚠ CAUTION

- When installing a motor spindle, do not hit, drop or cause shock to the motor spindle. This may cause damage to internal components and result in malfunctions.
- Cautions when tightening the securing bolt
Do not over tighten the bolt. This may cause damage to motor spindle's precision. Tighten the bolt until the motor spindle body can not be turn by hand within the fixture. Extreme tightening is not necessary or recommended.
Apply working force and check that the motor spindle is tight before using. (When adjusting the clamping level, refer to Section 15 "MOTOR CURRENT DISPLAY AND ADJUSTING THE CLAMPING LEVEL" of the iSpeed3 control unit Operation Manual.)

RECOMMENDATIONS

- Advice when using split type holders and all similar types of installation methods.
Insert a shim into the holder bore, and tighten the bolt with minimal torque.
Manufacture the holder with roundness and cylindrical tolerance of less than 5 μ m.

Insert a thin shim into the split in the holder and reduce the shim size in 5µm increments until motor spindle is held firmly.
 Tighten the clamping bolt to the torque specified for that size and type of bolt.
 The final responsibility for ensuring product's stability for use in a given application is left to the designer of the equipment in which NAKANISHI's motor spindle is installed.
 NAKANISHI offers motor spindles with a wide variety of capabilities and specifications.
 Please carefully check the product's specifications against the requirements of your application and verify suitability and safety prior to initial use.

13-2 Fixturing a flange type motor spindle : BM319F/BM319FC, BM320F, BM322FR and BM322FL.

⚠ CAUTION

If the motor spindle housing diameter section is inserted and tightened using bolts or set screws, or in a solid sleeve or a split holder arrangement, the main body will be geometrically deformed and assembly accuracy will be compromised.
 Problems such as rotation failure and heat generation will result. Absolutely never affix the motor spindle with a bolt or set screw when using split type holders.

A flange type motor spindle is a motor spindle that installs with a factory mounted flange, without inserting a sleeve over the motor spindle housing diameter section. This is designed to eliminate deformation/damage of the motor spindle when performing the installation.

- (1) Insert the motor spindle housing diameter section into the machines tool plate bore.
- (2) Secure the motor spindle through the counter-sunk holes (2 locations) on the flange face using bolts as shown in Motor S pindle Operation Manual Fig. 2, Fig. 4, Fig. 6 and Fig. 7. Refer to table 1 and Fig. 27.

Table 1

Bolts	M4 Bolts (M4 x 25)	BM319F/BM319FC, BM320F
	M5 Bolts (M5 x 25)	BM322FR, BM322FL

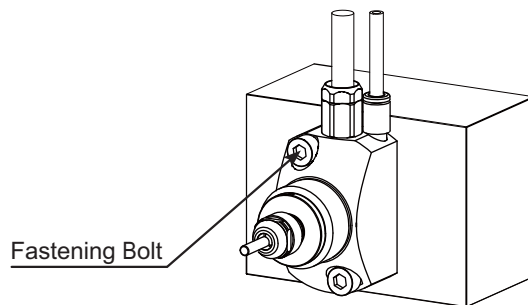

Fig. 27

14. MOTOR CURRENT DISPLAY AND ADJUSTING THE CLAMPING PRESSURE

14-1 MOTOR CURRENT DISPLAY

The Control Unit has a function that displays load on the motor spindle in current (x10mA). (Refer to section 6-1" Front face details ⑩"). This display allows you to confirm the load/clamping level when fixing the Motor Spindle in fixtures.

14-2 Clamping the Motor Spindle

Adjust the clamping pressure level using the motor current display. Run the motor spindle at any speed and note the current level while the motor spindle is not secured in any manner. Insert the motor spindle into the fixture and carefully and slowly tighten. **The Clamped Current Display should never be more than +1 (+10mA) of the current load reading before clamping.** This is a very important step when installing the iSpeed3 Motor Spindle.

15. AIR HOSE CONNECTION AND AIR PRESSURE SETTINGS

15-1 Air Hose Connection

⚠ CAUTION

1. Regulate the air pressure between 0.2-0.5MPa. If inlet air pressure is too low the control unit will not operate and an error E7 occur.
2. The cooling air provides two functions, to cool the electric motor and to protect the spindle from contaminants by providing a positive airflow.
3. Do not make any sharp bends in the air hose. Do not pull sharply on the air hose, as this can cause the air hose to break, cutting off the air supply or weaken the air hose over time. This will result in the deterioration of the motor and spindle.
4. Never supply over recommended regulated air pressure. There is a possibility of damage to the air detection function within the control unit. This detector recognizes air input only, not air output.
5. If there is damage to the Air Out hose, the control unit is not able to detect that there is no air being supplied to the motor spindle. This will cause premature motor spindle failure.

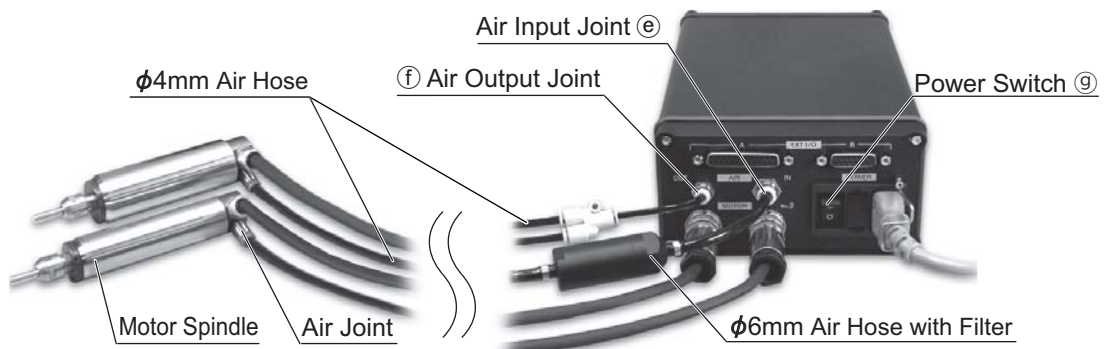

Fig. 28

- (1) Insert the provided $\phi 6\text{mm}$ air hose with filter from the AL-0201 Air Line Kit into the air inlet joint (e) on the rear of the control unit. (If you are not using the AL-0201 Air Line Kit make sure that the inlet air supply is dry, clean, regulated air.)
- (2) Insert the provided $\phi 4\text{mm}$ air hose into the back of the motor spindle.
- (3) Insert the other side of the $\phi 4\text{mm}$ air hose into the Air Output Joint on the rear of the control unit. When connecting two motor spindles to the control unit, use the Air Branching Joint that has been provided. This Air Branching Joint is to be used with only 2-Meter, 3-Meter and 5-Meter Motor cord/Air Lines. **Two (2) Motor Spindles cannot be connected to the control unit when using a 7-Meter Motor Cord/Air Line.**
- (4) Set the air supply pressure according to Section 15-2 "Setting The Air Supply Pressure" table 2.

15-2 Setting The Air Supply Pressure

The air pressure requirement varies with the number of the motor connections and the length of the air hose (Quick Disconnect Cord and Motor Cord). Verify the number of spindles and motor cord length before setting the pressure according to Table 2

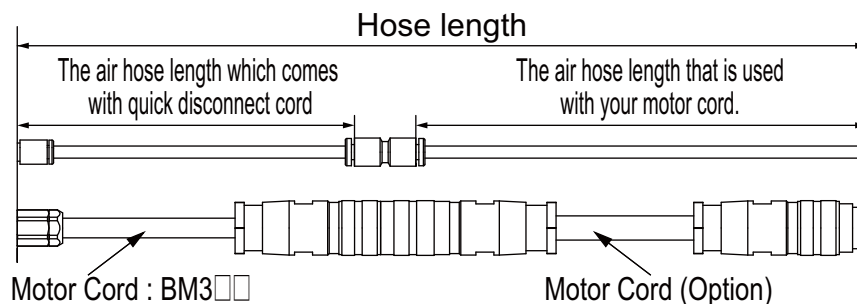

Fig. 29

Table 2

Total Hose Length(m) *Note 1		3.5	4.0	4.5	5.5	6.0	7.0	7.5	8.0	9.0
(1) One Motor Spindle is connected to the Control Unit.	Air Pressure (MPa)	0.2		0.25			0.3			
(2) Two Motor Spindles are connected to the Control Unit.		0.4		0.5						Not Allowed. *Note 2

*Note 1 : "Hose Length" indicates total hose length consisting of the Quick Disconnect Hose and the Motor Cord Hose. See Fig 29 to see how to calculate "Hose Length".

*Note 2 : 2 Meter Type (2M) Quick Disconnect Cord **CAN NOT** be used with a 7 Meter (7M) Motor Cord.

16. BREAK-IN PROCEDURE

The iSpeed3 Series is a high-precision, high-speed motor spindle. The following procedure must be followed to ensure proper motor spindle operation and longevity.

The grease inside the bearings will settle during transportation, storage or service. If the motor spindle suddenly runs at high speeds, grease will evacuate from the bearings, causing excessive heat resulting in bearing damage. After initial installation, repair, or long periods of non operation, please follow the break-in procedure detailed in Table 3. For 60,000 min⁻¹ spindles, follow steps 1 through 5. For 80,000min⁻¹ spindles, follow steps 1 through 6.

Table 3

Steps	1	2	3	4	5	6
Rotation Speed (min ⁻¹)	15,000	30,000	40,000	50,000	60,000	80,000
Running Time (min)	15	10	10	15	10	10
Items to check	No Abnormal Noises	Spindle housing no hotter than 20°C. If hotter than 20°C stop for at least 20 minutes, check installation and restart Break-in procedure.			Spindle housing no hotter than 20°C.	

17. OPERATION PROCEDURES

17-1. Select Control Mode (Manual/Auto)

(1) Using the CONTROL (CTRL) Button ⑨ you can select between Manual (Front panel control) or Auto (External Signal Source) modes. External Signal Source can be used to control Motor Start/Stop, Rotation Direction, Motor Speed etc. From an external control source (CNC).

(2) Manual Mode : Front panel option.

Auto Mode : Control by External Signal Source.

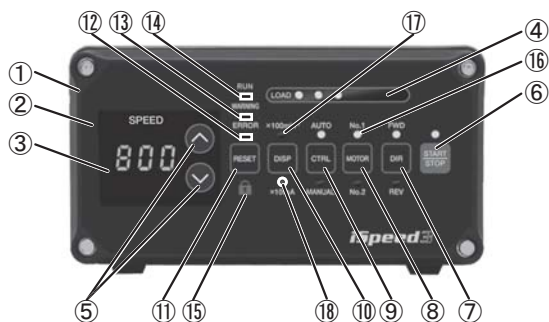

Fig. 30 Front face details

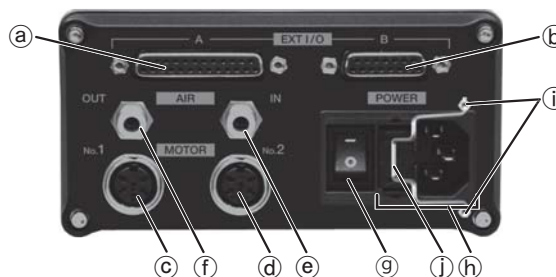

Fig. 31 Rear face details

17-2 Setting Motor Rotating Direction, Motor Start/Stop, Motor Speed.

17 -2-1 Setting Manual Mode

- (1) Set Motor Rotating Direction
Push the Motor Rotation Direction Button ⑦.
Select FWD. Right hand rotation.
Select REV. Left hand rotation.
- (2) Motor Start/Stop
Push Start/Stop Button ⑥ and START LED will illuminate.
- (3) Setting Motor Speed
Set the speed by pushing the Motor Speed Adjustment Button ⑤ .
 - Motor Speed Range is 1,000-80,000 min⁻¹. (BM319/BM319F/BM319FC, BM320/BM320F)
 - Motor Speed Range is 1.000-60,000 min⁻¹. (BM322/BM322FR/BM322FL, BM325)
 - The Motor speed is displayed in 100 min⁻¹. 800 = 80,000 min⁻¹.















17-2-2 Setting Auto Mode

All the iSpeed System functions can be controlled by Input Control Signals to Input/Output Connector A ②

- (1) Setting Motor Rotation Direction
Input the Motor Rotation Direction Signal to Pin No.2 : DIR_IN.
Right hand rotation is OFF 'Open' ("FWD." LED will light).
Left hand rotation is ON 'Closed' ("REV." LED will light).
- (2) Motor Start/Stop
Input the Motor Start Signal from Pin No. 14 : START.
Motor Rotating is ON 'Closed' (START/STOP LED will light).
Motor Stop is OFF 'Open' (START/STOP LED is off).
- (3) Setting Motor Speed
Input the Motor Speed Signal to Pin No.23 : VR
 - Motor Speed Range is 1,000 - 80,000min⁻¹
 - The Motor speed is displayed in min⁻¹. 800 equals 80,000min⁻¹

17-3 Setting other Parameters

The following Parameters can also be preset.

-  Error Output Signal.
-  Front Panel or External Signal Speed Control during Auto Mode Operation.
-  Fixed Motor Rotation Speed.
-  Maximum Motor Speed.
-  Selection of External Motor Speed Signal.
-  External Motor Start Command Signal Method.
-  Selection of Motor Acceleration and Deceleration Time
-  Selection Emergency Operating Function.
-  Setting the Level of Speed Achievement.
-  Error History Display.
-   -  Confirmation of Parameter  - 

Please refer to section 21 "SETTING OF OPERATING PARAMETERS" of this manual for details.

18. EXTERNAL INPUT/OUTPUT CONTROL SIGNAL SPECIFICATIONS

18-1. Input/Output connector A ②

- (1) Input/Output connector A ②

WARNING

Do not connect any circuit other than SELV (24VDC)(Safety Extra Low Voltage) to the External Input/Output connector A ②, This will cause I/O board damage in the control unit.

CAUTION

**Input/Output connector A ② DO NOT USE PIN No. 16.
If PIN No. 16 is connected, the control unit will be damaged.**

Table 3

Pin No.	Pin Name	Description	Input/Output	Signal	Function
1	COM_1	External Power Source for External Inputs	Input	0V or +24VDC	Power source to be used for External Inputs Signals.
2	DIR_IN	Rotating Direction Signal	Input	OFF (Open) : FWD. ON (Closed) : REV.	Controls the rotational direction of the motor spindle.
3	CNT_IN	Speed Change Pulse Signals	Input	OFF (Open) → ON (Closed)	One pulse will increase or decrease 100min ⁻¹ in Spindle Speed depending on (parameter $\text{P } \text{S}$) setting.
4	RESET	Error Release Signal	Input	ON (Closed) → OFF (Open)	Error Code can be released and the system restarted by toggling this signal OFF and ON.
5	SEL1	Speed Change Point Select Signal "1"	Input	OFF (Open) ON (Closed)	Select 4 Motor Speeds by using SEL0 and SEL1. (Refer to table 4.) (Refer to parameter $\text{P } \text{S}$ for the setting of Speed Point U1 - U2.)
6	RUN	Rotating Signal	Output	OFF (Open) : Stopped ON (Closed) : Rotating	Output shows that the motor is rotating.
7	DIR_OUT	Rotating Direction Signal	Output	OFF (Open) : FWD ON (Closed) : REV	Output shows the direction of the Motor is rotating.
8	ERR	Error Signal	Output	OFF (Open) : Normal ON (Closed) : Error	Error has occurred. (Parameter $\text{P } \text{S}$)
9	MT_SEL	Motor Select Signal	Input	OFF (Open) : Motor No.1 ON (Closed) : Motor No.2	Select the Motor to be used.
10	SEL_MT	Selected Motor Signal	Output	OFF (Open) : Motor No.1 ON (Closed) : Motor No.2	Output shows the selected motor No.
11	Vcc	Internal Power Source For Analog Signals	Output	+10DC	Power source for VR 1 and VR 2.
12	Motor_I	Motor Current Monitor	Output	0-10V DC 1.0A/V	Output shows the Motor current consumption. Output Voltage is proportional to the Motor Current consumption.
13	GND	Internal Ground	Output	Internal GND	This GND to be used for Analog Output Circuits.
14	START	Rotate Command Signal	Input	OFF (Open) : Stop ON (Closed) : Rotation	Start and Stops Motor Rotation.
15	UD_IN	Pulse Speed Change UP/DOWN Signal	Input	OFF (Open) : Speed Down ON (Closed) : Speed Up	Determines speed up or speed down. (parameter $\text{P } \text{S}$)
16	—	Not used	—	—	—
17	SEL0	Speed Change Point Select Signal "0"	Input	OFF (Open) ON (Closed)	Select 4 Motor Speeds by using SEL0 and SEL1. (Refer to table 4.) (Refer to parameter $\text{P } \text{S}$ for the setting of Speed Point U1 - U2.)
18	COM_2	External Power Source for External Output	Input	0V or +24V DC	Power Source to be used for External Output Signals.
19	PULSE	Rotating Pulse	Output	1 Pulse / Rotation	1 revolution of the motor generates one pulse. Duty 50%.
20	WARNING	Warning Signal	Output	OFF (Open) : Normal Operation ON (Closed) : Warning	Shows a Warning has Occurred. The Warning Code is shown on the Digital Speed Indicator ③.
21	COIN	Speed Achievement Signal	Output	OFF (Open) : Set Speed not achieved ON (Closed) : Set Speed achieved	Shows that the Motor has achieved more than 90% of the set Speed. (parameter $\text{P } \text{S}$)
22	VR2	Motor No.2 Speed Control Signal	Input	Motor No. 2 Speed Control Signal	Sets rotating speed of motor No. 2. 10,000min ⁻¹ /V. (Based on 80,000min ⁻¹ Max.)
23	VR1	Motor No.1 Speed Control Signal	Input	Motor No. 1 Speed Control Signal	Sets rotating speed of motor No.1. 10,000min ⁻¹ /V. (Based on 80,000min ⁻¹ Max.)
24	LOAD	Torque Load Monitor	Output	0-10V DC 20%/V	Shows that the torque being applied to the motor. 20%/V 100%(rating)/5V
25	SPEED_V	Rotating Speed Monitor Voltage	Output	10,000 min ⁻¹ /V	Voltage Output is proportional to the Motor Speed

Table 4. Speed Point can be set with parameter setting $\text{P } \text{S}$

Speed Point	SEL1 (Pin No.5)	SEL0 (Pin No.17)
U1	OFF (Open)	OFF (Open)
U2	OFF (Open)	ON (Closed)
U3	ON (Closed)	OFF (Open)
U4	ON (Closed)	ON (Closed)

(2) Input/Output Diagram

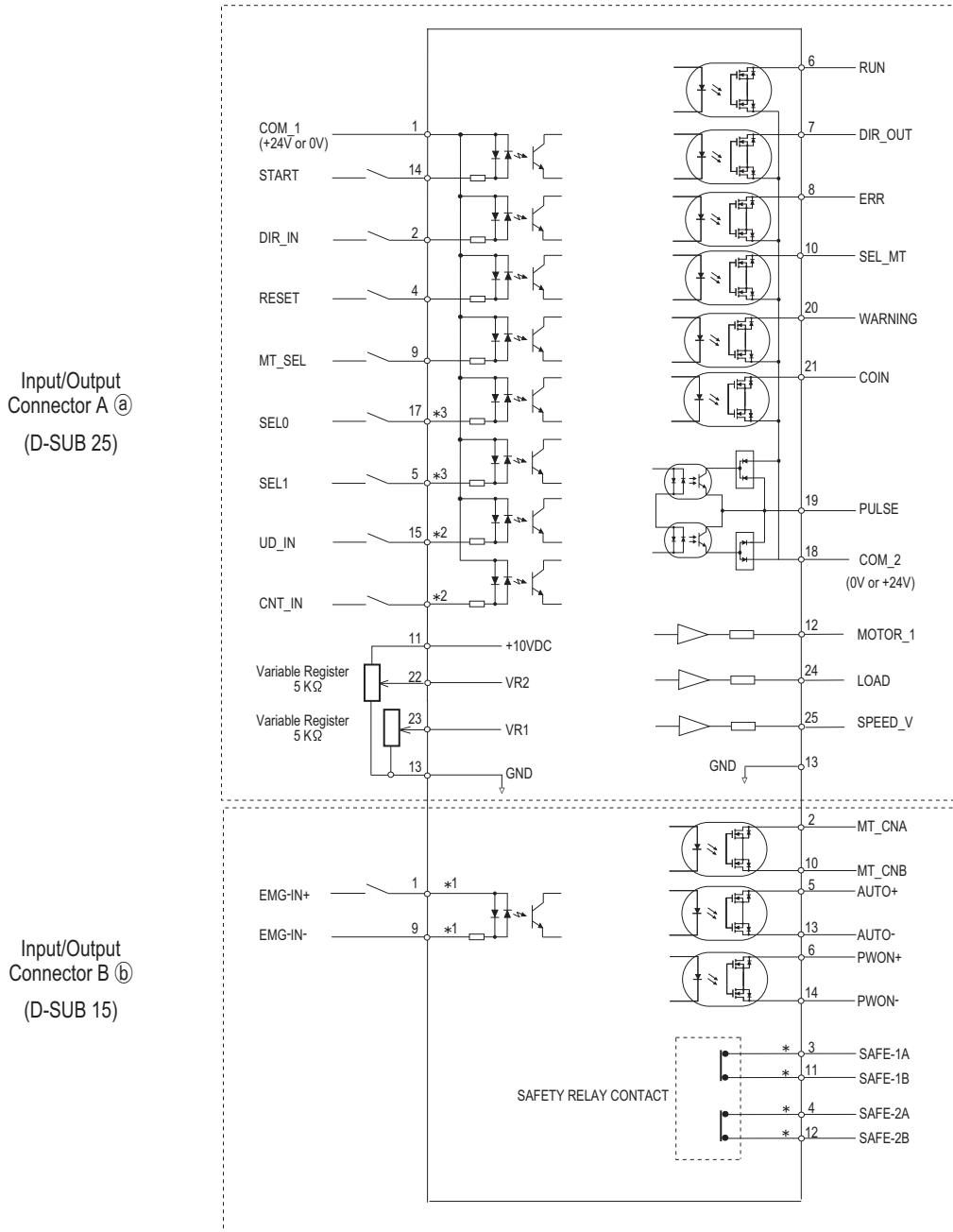

Fig. 32

- * 1 : By setting parameter $P 0$, EMG-IN Signal can be used.
- * 2 : By setting parameter $P S$, Motor Speed Change is possible by Pulse Signals.
- * 3 : By setting parameter $P S$, Motor Speed Change is possible by SEL0 and SEL1.

(3) Input/Output Signal

(3) -1 Input Signal

There are 8 command Input Signals : Rotation Command, Rotation Direction, Error Release, Speed Up or Down Signal, Speed Command Pulse Signal, Motor Selection Signal, Set Speeds for Motor No. 1 / Motor No. 2.

Please use a separate power source that is Capable of supplying 24VDC±10%, 100mA (min). Refer to Figures below for connections.

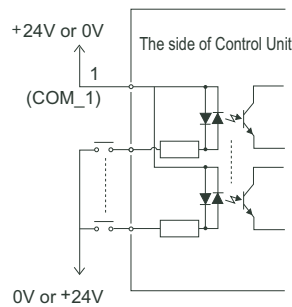

Fig. 33

(3) -2 Output Signal I

There are 6 command Output Signals : Spindle Rotating, Rotation Direction, Error, Warning, Selected Motor, Rotating Speed Achieved. These signals are MOS Relay Connections. The Output Signal can be connected to either a sinking or source type connections.

Voltage and Current Specifications

- Applied Voltage (V max) \leq 30VDC
- Working Current (Ip) \leq 100mA

Use a separate External Power Source for Output Circuits.

It is recommended to use a separate 24VDC Power Source other than the one used for Input Signals.

Please refer to Fig. 34 for connections.

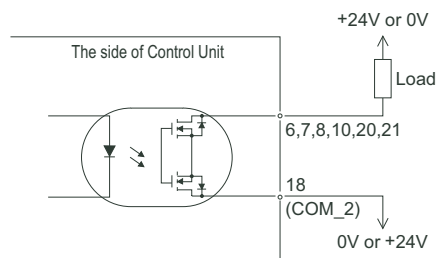

Fig. 34

(3) -3 Output Signal II

Refer to Fig. 35 for about the Output Signal of Rotating Pulse.

This signal is a Photo Coupler connection. This output can be connected to either a sinking or source type connection.

Voltage and Current Specifications

- Applied Voltage (V max) \leq 30VDC
- Working Current (Ip) \leq 100mA

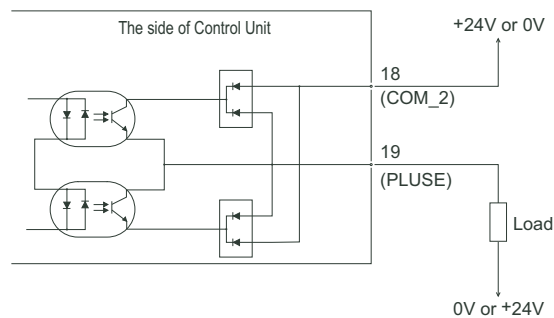
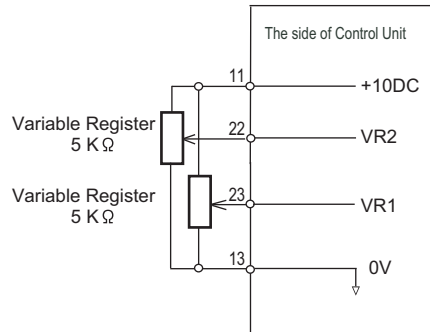

Fig. 35

(3) -4 Motor Speed Control Signal

Refer to Fig. 36, 37 for connections. Please refer to Fig. 38 about relationship between Motor speed and Control signal.

When applying voltage, never input more than 10VDC. This will avoid damaging the Control Unit. (Fig. 37)



Vin: Speed Control Signal
Vin must be less than 10VDC

Fig. 36

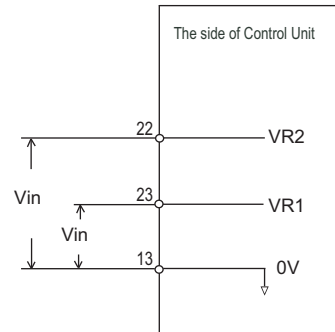

Fig. 37

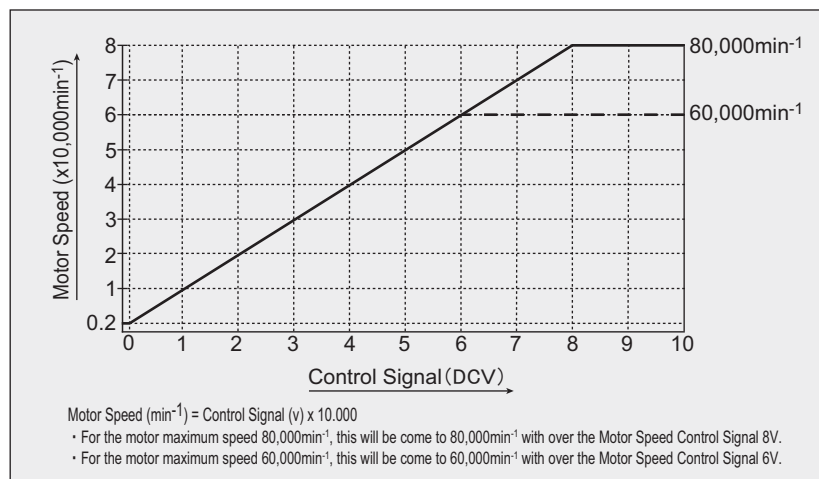

Fig. 38

(3) -5 Monitoring Signals

There are 3 Monitoring Signals : Motor Current, Torque Load Monitor and Rotating Speed Monitor. Please refer to Fig. 39 for connections.

- Motor Current Monitor
- Torque Load Monitor
- Rotating Speed Monitor Voltage

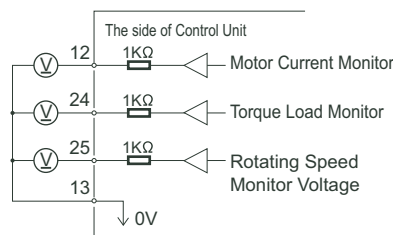

Fig. 39

18-2. Input/Output Connector B ⑥

(1) Input/Output Connector B ⑥

WARNING

Do not connect any Circuit other than SELV (24VDC)(Safety Extra Low Voltage) to the External Input/Output Connector B ⑥. This will cause I/O board damage in the control unit.

CAUTION

**Input/Output connector B ⑥ DO NOT USE PINS No. 7, 8 and 15.
If PINS 7, 8 or 15 are connected, the Control Unit will be damaged.**

Table 5.

Pin No.	Pin Name	Description	Input/Output	Signal	Function
1	EMGIN-A	Emergency Stop Signal A	Input	Input for Emergency Stop Signal.	Emergency Stop Signal or Emergency Stop Signal power source. Normal Operation ON (Closed). EMERGENCY OFF (Open). Refer to Fig. 41.
2	MTCN-A	Motor Signal Contact Connector A	Output	Continuity OFF (Open) between MTCN-A and MTCN-B the Motor is connected.	When there is continuity, (OFF), between MTCN-A and MTCN-B the Motor is connected. If no continuity the Motor is disconnected.
3	SAFE-1A	Relay Contact 1A	Output	SAFE-1A and SAFE-1B continuity ON (Closed) Relay is OFF.	When there is continuity, (OFF), between SAFE-1A and SAFE-1B ON (Closed) Safety Relay is OFF (Emergency Stop), no continuity Safety Relay is OFF (Open) Normal Operation.
4	SAFE-2A	Relay Contact 2A	Output	SAFE-2A and SAFE-2B continuity ON (Closed) Relay is OFF.	When there is continuity, (OFF), between SAFE-2A and SAFE-2B ON (Closed) Safety Relay is OFF (Emergency Stop) no, continuity Safety Relay is OFF (Open) Normal Operation.
5	AUTO-A	AUTO Mode Signal A	Output	AUTO Mode Operation ON (Closed) .	When AUTO Mode is being used, AUTO-A and AUTO-B is ON (Closed)
6	PWON-A	Unit Power Source Monitor A	Output	ON (Closed) :Main Power Supply is connected. OFF (Open) : Main Power Supply is disconnected.	If the main power supply to the Control Unit is connected, PWON-A and PWON-B is ON (Closed)
7	-	Not Used	-	-	-
8	-	Not Used	-	-	-
9	EMGIN-B	Emergency Stop Signal B	Input	Input for Emergency Stop Signal.	Emergency Stop Signal or Emergency stop signal power source. Normal Operation ON (Closed), Emergency OFF (Open) Refer to Fig. 41.
10	MTCN-B	Motor Signal Connect Contact B	Output	Continuity OFF (Open) between MTCN-A and MTCN-B the Motor is connected.	When there is continuity, OFF, between MTCN-A and MTCN-B the Motor is connected. If no continuity the Motor is disconnected.
11	SAFE-1B	Relay Contact 1B	Output	SAFE-1A and SAFE-1B continuity ON (Closed) Relay is OFF.	When there is continuity, OFF, between SAFE-1A and SAFE-1B ON (Closed) Safety Relay is OFF (Emergency Stop), no continuity Safety Relay is OFF (Open) Normal Operation.
12	SAFE-2B	Relay Contact 2B	Output	SAFE-2A and SAFE-2B continuity ON (Closed) Relay is OFF.	When there is continuity, OFF, between SAFE-2A and SAFE-2B ON (Closed) Safety Relay is OFF (Emergency Stop), no continuity Safety Relay is OFF (Open) Normal Operation.
13	AUTO-B	AUTO Mode Signal B	Output	AUTO Mode Operation ON (Closed) .	When AUTO Mode is being used, AUTO-A and AUTO-B is ON (Closed)
14	PWON-B	Unit Power Source Monitor B	Output	ON (Closed) :Main Power Supply is connected. OFF (Open) : Main Power Supply is disconnected.	If the Main power supply to the Control Unit is connected, PWON-A and PWON-B is ON (Closed).
15	-	Not Used	-	-	-

(2) Input/Output Signal

(2)-1 Output Signal

PIN No. 2-10, 5-13, 6-14

There are 3 command Output Signals : "Motor Connection Monitoring" , "AUTO MODE" and "Control Unit Power Source Monitoring" .

These signals are MOS Relay Contact Connections. The Output Signal can be connected to either a sinking or source type connection.

Voltage and Current Specifications

- Applied Voltage (V max) \leq 30VDC
- Working Current (I_p) \leq 100mA

Use an External Power Source for Output Circuits. It is recommended to use a separate power from the one used for Input/Output Connector A @ . Please refer to Fig. 40 for connections.

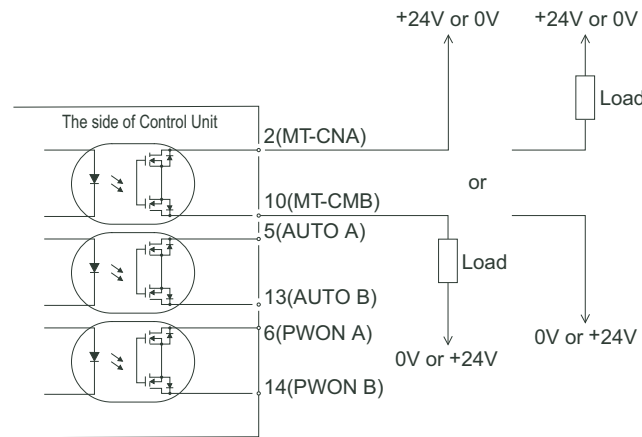

Fig. 40

(2)-2 Emergency Stop Signal Input

PIN No. 1-9

This signal is a +24V DC Signal for External Signal Source.

Please use a separate power source that is capable of supplying 24VDC \pm 10%, 50mA. Refer to Fig. 41 below for connections.

When Normal Operation Circuit is ON (Closed), the safety relay is on.

When the Emergency Stop Signal is OFF (Open) the Safety Relay is OFF and the power supply to the motor is interrupted and the Motor stops.

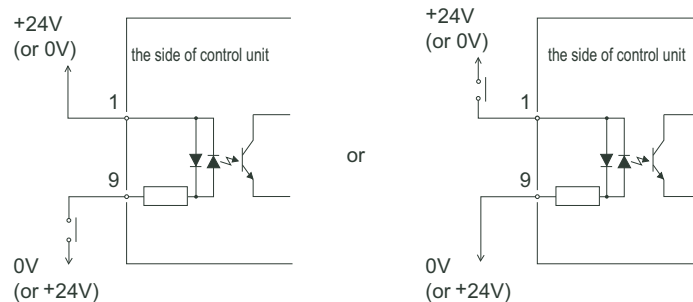

Fig. 41

(2) -3 Safety Relay Contact Signal
 PIN No. 3-11, 4-12

- The Safety Relay will be ON or OFF depending on the state of the Emergency Stop Signal PINS 1 and 9.
- When there is continuity between PIN3 (SAFE-1A) and PIN11 (SAFE-1B) or between PIN4 (SAFE-2A) and PIN12 (SAFE-2B) the Motor is off. If there is no continuity between these pairs of Pins then the system is operating normally.
- If the Emergency Stop Signal is OFF (Open) the Safety Relay will be OFF and the Motor Power will be interrupted and the Motor will stop.
- The Voltage/Current specifications of PINS 3-11 and PINS 4-12.
 Applied Voltage (V max) $\leq 30\text{VDC}$
 Working Current (Ip) $\leq 2\text{A}$
- The installed Safety Relay is designated to comply with EN standards.
 The separation of "b" contacts of the Safety Relay is maintained at more than 0.5mm spacing by relay's spring release mechanism. If the 'a' contacts of the Safety Relay are welded together, there has been an over load or short circuit.
- The 'b' contacts output can be used to detect an open circuit of the motor line and integrated with the machines safety systems. One such function is to signal a release of the safety guard lock of the machine.

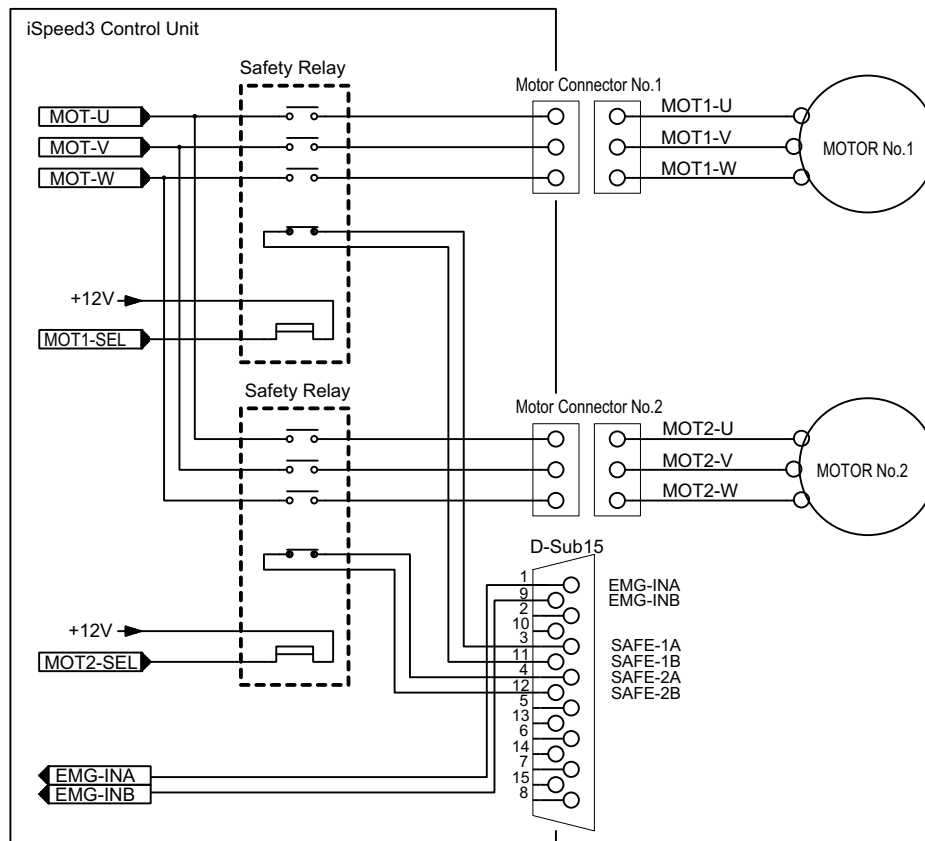

Fig. 42

18-3. Input/Output Connector A ① / B ② Specifications

(1)-1 Input/Output Connector A ①

Plug Part Number : XM2A-2501 OMRON (or other similar high-quality product)

Cover Part Number : XM2S-2511 OMRON (or other similar high-quality product)

(1)-2 Input/Output Connector B ②

Plug Part Number : XM2A-1501 OMRON (or other similar high-quality product)

Cover Part Number : XM2S-1511 OMRON (or other similar high-quality product)

*Screw size : M 2.6

⚠ CAUTION

- To minimize RF interference and noise, please keep the length of the cables as short as possible and route them separately or as far away as possible from high voltage electrical cables.
- Use only shielded cables to minimize RF interference and noise. Connect the shield to the plug cover.
- Connect the shielded line to the Input/Output connector. (the shielded line is grounded.) Do not connect another shielded line to any externally powered instrument.

18-4. Input/Output Connector A ① / B ② Pin Configuration

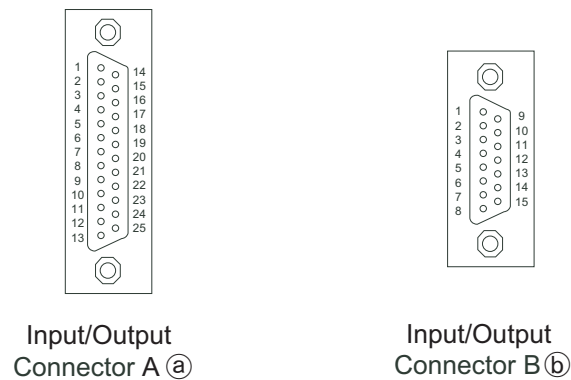

Fig. 43

19. PROTECT FUNCTION

19-1. Warning Function

Always check the Control Unit, Motor Spindle and the condition of the cooling air prior to use. This will help prevent system errors that will result in non-operational conditions.

- (1) The Warning LED ⑬ will flash.
- (2) The Warning Code (listed in Table 6) will be displayed on the Digital Speed Indicator ③ .
- (3) A Warning Signal is output to the Warning Signal (PIN No. 20 : WARNING) of Input / Output Connector A ④ .

CAUTION

When the Warning LED ⑬ flashes, please check the Warning Code.

Table 6.

Warning code	Warning Function	Trouble
A0	Motor Cord Disconnect	Motor Cord or Connector is disconnected or damaged.
A1	Low Air Pressure	Low Air Pressure.
A2	Control Unit Overheat	Control Unit Overheat.
A3	Over Load	Motor Torque Load Exceeding Safe Limits.
A4	Emergency Stop Signal	Emergency Stop Signal Has Been Activated.
A5	Over Air Pressure	Over Air Pressure.

19-2. Detection of unsafe operating conditions

Always check the Control Unit, Motor, Spindle and the condition of the cooling air prior to use. This will help prevent system errors that will result in non-operational conditions.

When an Error is generated, the following events will occur :

- (1) Motor stops
- (2) The Error LED ⑫ will flash.
- (3) Error Code (listed in Table 3) will be displayed on the Digital Speed Indicator ③ .
- (4) An Error Signal is output to the Error Signal (PIN No. 8 : ERR) of Input / Output Connector A ④ .

19-3. Resetting System after Error Codes

There are 2 methods of releasing Error Codes:

- (1) Push Reset Button ⑩ on the front panel.
- (2) Switch the signal on PIN4 (RESET) of Input / Output Connector A ⑨ OFF (Open) → ON (Closed) → OFF (Open).
When releasing Error using the Motor Start/Stop (Pin No. 14 : START) is ON (Closed), OFF (Open) Motor Start/Stop before resuming operation.

CAUTION

- If When using the Input / Output Connector A ⑨ / B ⑩ and External Monitoring, please check and resolve the source of the problem anytime a error code is displayed.
- When an error occurs due to internal damage of the control unit, the Error Signal can not be reset. Please send the Motor Spindle and Control Unit to a NAKANISHI dealer for repair.

Table 7.

Error code	Error Fault	Trouble
E1	Excess Current	Motor Current beyond safe limits
E2	Trouble with the Internal Power Supply	Trouble with Internal Power Supply or an internal component of the Control Unit as occurred.
E3	Motor Cord Disconnect	Motor Cord or Connector is disconnected, misaligned or damaged.
E4	Control Unit Overheat	Control Unit Overheated.
E5	Brake Circuit Trouble	Trouble with the Motor Brake Circuit.
E6	No Speed Signal	Loss of speed control sensing inside the motor caused by impact or torque overload.
E7	Low Air Pressure	Inadequate air supplied for more than 4 seconds during rotation or inadequate air supply when Motor start is command.
E8	Torque Over Load	Torque limits exceeded the factory pre-programmed time.
EA	External Control Signal Error	A spindle start command was executed while a start command is still active in the control.
EL	Incompatible Motor	Incompatible Motor is connected to the system.
EH	Over Speed	Rotating Speed is beyond the factory pre-programmed time.
EE	Emergency Stop Error	Safety Relay has been activated and the Emergency Stop System has stopped the Motor.
EC	Internal Memory Error	Trouble with the Memory (EEPROM)

19-4. Torque Overload

When the Load Monitor LED ④ lights 4 or more LED's (3 Green LED's and 1 or more Yellow LED's) an overload condition exists. During a motor overload period, the following will occur:

- (1) Warning LED ⑬ flashes
- (2) Warning Code "A3" is displayed on the Digital Speed Indicator ③ .
- (3) Warning Signal is output to the Warning Signal (Warning) of Input / Output Connector A ① /B ② .

Overload operation is considered short-term operation mode. The allowable operation time depends on the number of lighted LED's on the Load Monitor LED (Load).

The allowable time is detailed below.

- (1) Load Monitor LED 4 LED's : 30 Seconds
- (2) Load Monitor LED 5 LED's : 10 Seconds
- (3) Load Monitor LED 6 LED's : 5 Seconds

When the allowable time is exceeded the motor will stop and the following occurs:

- (1) Error LED ⑫ flashes.
- (2) Error Code E8 is displayed in the Digital Speed Indicator ③ .
- (3) Error Signal is output to the Error Signal PIN8 (ERR) of Input / Output Connector A ① .

CAUTION

If you constantly, operate the system in an overload condition, even for short periods of time, the control unit will overheat and damage to the control, motor and spindle are possible. NAKANISHI recommends only continuous duty operation (Load LED's with 3 LED's lit) : Torque Load Monitor (Load) Voltage should be less than 5V.

20. SETTING OF OPERATING PARAMETERS

20-1. The following operating parameters can be preset depending on the application requirements. The operating parameter presets are retained in non-volatile memory and will be maintained even if power is disconnected.

- 1) Setting the Error Output Mode P 1
When an operating error occurs, an Error Signal will be output to Input/Output Connector A ② .
This output can be set to normally ON (Closed) or normally OFF (Open).
This signal can be output through Pin 8.
- 2) Setting AUTO Mode Motor Speed Control P 2
Control Mode is set to AUTO.
 - Motor Speed can be controlled by the Motor Speed Adjustment Button ⑤ on the Control Panel.
- 3) Setting Fixed Motor Speed for Motor NO. 1 and NO. 2 P 3
 - Single Motor Speed is set.
 - Machine Operator can not change Motor speed while in AUTO Mode.
- 4) Setting the Maximum Motor Speed for Motor NO. 1 and NO. 2 P 4
 - Set maximum Motor speed to the maximum allowable speed for the cutting tools being used.
 - Set the maximum Motor speed to the maximum recommended speed for the material being machined.
- 5) Selection of External Input / Output Signal Speed P 5
External Speed Signal when in AUTO Mode: Speed can be changed manually at the Control Unit, variable DC voltage, speed change with Pulse or change at Speed Point can be selected.
Speed change using Speed Point is a method to select speeds using the four (4) rotation speeds preset according to the External Signal (SEL0/1).
Speed change by pulse is set with the External Signal (CNT-IN/UD-IN).
- 6) Selection of the type of External Signal for Motor start method P 6
Allows selection of Start Signal and Direction Signal or REV. Start and FWD. Start Signals.
- 7) Selection of Motor Speed Acceleration Time and Deceleration Time P 7
Select Acceleration Time/Deceleration Time in seconds.
- 8) Selection Emergency Operating Function P 8
Motor rotation is stopped by Emergency Stop Signal.
- 9) Setting the Level of Speed Achievement P 9
Motor rotation Achievement Signal (COIN) is output according to Motor Achievement Level.
- 10) Error History P 10
Display of up to 5 previous Error Codes.
Up to 5 error codes can be memorized.

20-2. Entering Parameter Setting Mode

While pushing and holding the Reset Button ⑪ turn the Power Switch ⑨ at the rear of the Control Unit On. Hold the Reset Button down for 3 seconds, the buzzer will 'BEEP' 3 times, release the Reset Button ⑪ and Parameter Setting Mode will start. The Start LED flashes to indicate Parameter Setting Mode is active.

- After entering Parameter Setting Mode the parameters to be set can be selected by pushing the Motor Speed Adjustment Button ⑤ .

	Error Output Mode
	AUTO Mode Motor Speed Control
	Fixed Motor Speed
	Maximum Motor Speed
	External Speed Control Mode
	External Motor Start Signal Control Mode
	Acceleration time/Deceleration time
	Emergency Stop Selection Mode.
	Speed Achievement Level
	Error History
	Confirm settings of parameters

20-3. Setting Procedure

20-3-1. Setting Error Output Mode

- Allows setting of the Output Signal on PIN No. 8 : ERR of Input/Output Connector A ② .
- When an error occurs the output can be set to ON (Closed) or OFF (Open).

Procedure

- 1) Push the Start/Stop Button ⑥.
- 2) is displayed. This indicates that when an error occurs, the output will be OFF (Open).
- 3) Push the Start/Stop Button ⑥.
- 4) is displayed. This indicates that when an error occurs the output will be ON (Closed).
- 5) You can cycle through the choices by pushing the Start/Stop Button ⑥.
- 6) Push the Reset Button ⑪ to send the settings to memory, will be displayed on the LCD readout.
- 7) If you desire to set other parameters, push the Motor Speed Adjustment Button ⑤ to select the parameter that needs to be set.
- 8) When you are finished setting parameters, press the Reset Button ⑪, then turn the Main Power Switch ⑨ OFF.

If the Error Output Mode has been changed from the default setting, that setting will be displayed the next you enter Parameter Setting Mode.

20-3-2. Setting AUTO Mode Motor Speed Control P 2

- Allows the setting of the manner in which Motor speed can be controlled when the system is being used in AUTO mode (External Command Signal Control).
- This parameter selects between speed control with the Motor Speed Adjustment Button 5 or by External Command Signal through Input / Output Connector A a.

Procedure

- 1) Push the Start/Stop Button 6.
- 2) eff is displayed. This indicates that speed control is by External Command Signal Control and the Motor Speed Adjustment Button 5 is disabled.
- 3) Push the Start/Stop Button 6.
- 4) en is displayed. This indicates that speed control is changeable by the Motor Speed Adjustment Button 5 and the External Command Signal Control for speed is disabled.
- 5) You can cycle through the choices by pushing the Start/Stop Button 6.
- 6) Push the Reset Button 11 to send the settings to memory, P 2 will be displayed depending on the parameter being set.
- 7) If you desire to set other parameters, push the Motor Speed Adjustment Button 5 to select the parameter to be set.
- 8) If you are finished setting parameters, press the Reset Button 11, then turn the Main Power Switch 9 OFF.

20-3-3 Setting Fixed Motor No. 1, No. 2 Speed P 3

- Allows the Motor speed to be fixed.
- Fixes the Motor speed in both MANUAL and AUTO modes.





















Procedure

- 1) Push the Start/Stop Button 6.
- 2) P 3.1 is displayed. This indicates the setting of Motor No. 1.
- 3) Push the Start/Stop Button 6.
- 4) eff is displayed. This indicates that Fixed Motor No. 1 Speed can not be set.
- 5) Push the Start/Stop Button 6.
- 6) The Digital Speed Indicator will display the selected Motor No. 1 speed.
The Motor speed can be set by pushing the Motor Speed Adjustment Button 5.
The speed control range is 1,000 - 60,000min⁻¹ or 1,000 - 80,000min⁻¹.
- 7) To set the desired speed, push the Reset Button 11. When the setting is memorized, P 3.1 is displayed.
- 8) Push the Motor Speed Adjustment Button 5. The indicator will display P 3.2.
This indicates the setting of Motor No.2.
- 9) Push the Start/Stop Button 6.
- 10) eff is displayed. This indicates that Fixed Motor No. 2 Speed can not be set.
- 11) Push the Start Button/Stop 6.
- 12) The Digital Speed Indicator will display the selected Motor No. 2 Speed.
The Motor speed can be set by pushing the Motor Speed Adjustment Button 5.
The speed control range is 1,000 - 60,000min⁻¹ or 1,000 - 80,000min⁻¹.
- 13) To set the desired speed, push the Reset Button 11. When the setting is memorized, P 3.2 is displayed.
- 14) Push the Reset Button 11. P 3 is displayed.
- 15) If you desire to set other parameters, push the Motor Speed Adjustment Button 5 to select the parameter to be set.
- 16) If you are finished setting parameters, press the Reset Button 11, then turn the Main Power Switch 9 OFF.





20-3-4 Setting Fixed Motor No.1 and No. 2 Speeds

- Allows the Motor speed to be fixed.
- Fixes the Motor speed in both MANUAL and AUTO modes.















Procedure

- 1) Push the Start/Stop Button .
- 2)  is displayed. This indicates the setting of Motor No. 1.
- 3) Push the Start/Stop Button .
- 4)  is displayed. This indicates that Maximum Motor No. 1 Speed can not be set.
- 5) Push the Start/Stop Button .
- 6) The Digital Speed Indicator will display the selected Motor No. 1 speed.
The Motor speed can be set by pushing the Motor Speed Adjustment Button .
- The speed control range is 1,000 - 60,000min⁻¹ or 1,000 - 80,000min⁻¹.
- 7) To set the desired speed, push the Reset Button . When the setting is memorized,  is displayed.
- 8) Push the Motor Speed Adjustment Button . The indicator will display .
- This indicates the setting of Motor No. 2.
- 9) Push the Start/Stop Button .
- 10)  is displayed. This indicates that Maximum Motor No. 2 Speed can not be set.
- 11) Push the Start/Stop Button .
- 12) The Digital Speed Indicator will display the selected Motor No. 2 speed.
The Motor speed can be set by pushing the Motor Speed Adjustment Button .
- The speed control range is 1,000 - 60,000min⁻¹ or 1,000 - 80,000min⁻¹.
- 13) To set the desired speed, push the Reset Button . When the setting is memorized,  is displayed.
- 14) Push the Reset Button .  is displayed.
- 15) If you desire to set other parameters, push the Motor Speed Adjustment Button  to select the parameter to be set.
- 16) If you are finished setting parameters, press the Reset Button , then turn the Main Power Switch  OFF.

20-3-5 Setting External Speed Control Mode

- Allows the setting of External Speed Control Mode.
- The External Speed Control Signal can be set using variable voltage DC Signal, a Pulse Signal or Speed Point Signal.
- Set Analog Signal (Pin No. 23 : VR1 and Pin No. 22 : VR2), set Pulse (Pin No. 3 : CNT-IN/Pin No. 15 : UD-IN) or set Point (Pin No.17 : SEL0, Pin No.5 : SEL1).
- When using the Pulse Signal, Speed down (Open) or Speed up (Closed) is selected by using the UD-IN signal, and change to the Motor speed is changed by pulsing the CNT-IN Signal. The Motor Speed Change per Pulse is 100 min⁻¹/pulse.
When using the Point Signal, the Motor Speed is set by one of the 4-preset speeds. 4-preset speeds can be selected by 2 signals (Pin No.17 : SEL0 and Pin No.5 : SEL1).  -  preset speed is for Motor No. 1 and  -  preset speed is for Motor No. 2.

Procedure

- 1) Push the Start/Stop Button .
- 2)  is displayed. The Motor speed is controlled by Analog Signal. (Pin No. 23 : VR1 and Pin No. 22 : VR2).
- 3) Push the Motor Speed Adjustment Button  - .
- 4)  is displayed. The Motor speed is controlled by Pulse Signal. (Pin No. 3 : CUT-IN, Pin No. 15 : UD-IN).
- 5) Push the Motor Speed Adjustment Button  - .
- 6)  is displayed. The Motor speed is controlled by Point Signal (Pin No. 17 : SEL0, Pin No. 5 : SEL1).
- 7) Push the Start/Stop Button .
- 8)-1  is displayed. This indicator that Motor No. 1 Speed Point 1 can be set.
- 8)-2 The Digital Speed Indicator  will oscillate between  and the Motor speed can be selected by pushing the Motor Speed Adjustment Button .
- Speed control range is 1,000 - 60,000min⁻¹ or 1,000 - 80,000min⁻¹.
- 8)-3 Push the Start/Stop Button .
- 8)-4  is displayed. This Indicates that Motor No. 1 Point Speed 2 can be set.

- 8)-5 The Digital Speed indicator ③ will oscillate between $\boxed{1.2}$ and the Motor speed can be selected by pushing the Motor Speed Adjustment Button ⑤.
Speed control range is 1,000 - 60,000min⁻¹ or 1,000 - 80,000min⁻¹.
- 8)-6 Push the Start/Stop Button ⑥.
- 8)-7 $\boxed{1.3}$ is displayed. This indicates that Motor No. 1 Speed Point 3 can be set.
- 8)-8 The Digital Speed Indicator ③ will oscillate between $\boxed{1.3}$ and the motor speed can be selected by pushing the Motor Speed Adjustment Button ⑤.
Speed control range is 1,000 - 60,000min⁻¹ or 1,000 - 80,000min⁻¹.
- 8)-9 Push the Start/Stop Button ⑥.
- 8)-10 $\boxed{1.4}$ is displayed. This indicates that motor No. 1 Speed Point 4 can be set.
- 8)-11 The Digital Speed Indicator ③ will oscillate between $\boxed{1.4}$ and the motor speed can be selected by pushing the Motor Speed Adjustment Button ⑤.
Speed control range is 1,000 - 60,000min⁻¹ or 1,000 - 80,000min⁻¹.
- 8)-12 Push the Start/Stop Button ⑥.
- 8)-13 $\boxed{2.1}$ is displayed. This indicates that motor No. 2 Speed Point 1 can be set.
- 8)-14 The Digital Speed Indicator ③ will oscillate between $\boxed{2.1}$ and the Motor speed can be selected by pushing the Motor Speed Adjustment Button ⑤.
Speed control range is 1,000 - 60,000min⁻¹ or 1,000 - 80,000min⁻¹.
- 8)-15 Push the Start/Stop Button ⑥.
- 8)-16 $\boxed{2.2}$ is displayed. This indicates that motor No. 2 Speed Point 2 can be set.
- 8)-17 The Digital Speed Indicator ③ will oscillate between $\boxed{2.2}$ and the Motor speed can be selected by pushing the Motor Speed Adjustment Button ⑤.
Speed control range is 1,000 - 80,000 min⁻¹.
- 8)-18 Push the Start/Stop Button ⑥.
- 8)-19 $\boxed{2.3}$ is displayed. This indicates that motor No. 2 Speed Point 3 can be set.
- 8)-20 The Digital Speed Indicator ③ will oscillate between $\boxed{2.3}$ and the Motor speed can be selected by pushing the Motor Speed Adjustment Button ⑤.
Speed control range is 1,000 - 60,000min⁻¹ or 1,000 - 80,000min⁻¹.
- 8)-21 Push the Start/Stop Button ⑥.
- 8)-22 $\boxed{2.4}$ is displayed. This indicates that motor No. 2 Speed Point 4 can be set.
- 8)-23 The Digital Speed Indicator ③ will oscillate between $\boxed{2.4}$ and the Motor speed can be selected by pushing the Motor Speed Adjustment Button ⑤.
Speed control range is 1,000 - 60,000min⁻¹ or 1,000 - 80,000min⁻¹.
- 8)-24 Push the Reset Button ⑪ to send the setting memory, $\boxed{P 5}$ will be displayed depending on the parameter to be set.
- 8)-25 If you desire to set other parameters, push the Motor Speed Adjustment Button ⑤ to select the parameter to be set.
- 8)-26 If you are finished setting parameters, press the Reset Button ⑪, then turn the Main Power Switch ⑨ OFF.

20-3-6 Setting External Motor Start Signal Control Mode $\boxed{P 6}$

- During Auto Control Mode, the Motor Start Signal can be used for either direction by commanding a Direction Signal and a Start Signal. When $\boxed{P 6}$ is set to \boxed{EFF} , the rotation direction is controlled by Pin No. 2 DIR_IN, FWD. (Open), REV. (Closed) and the Start Signal is controlled by Pin No. 14 : START.
When $\boxed{P 6}$ is set to \boxed{EN} FWD. rotation is controlled by Pin No. 14 : START and REV. rotation is controlled by Pin No. 2 : DIR_IN.













Procedure

- 1) Push the Start/Stop Button ⑥.
- 2) \boxed{EFF} is displayed. This indicates that the control mode is set to Direction Signal and Start Signal.
- 3) Push the Start/Stop Button ⑥.
- 4) \boxed{EN} is displayed. This indicates that control mode is set to FWD. ON, REV. ON mode.
- 5) Push the Reset Button ⑪ to send the settings to memory. $\boxed{P 6}$ will be displayed depending on the parameter being set.
- 6) If you desire to set other parameters push the Motor Speed Adjustment Button ⑤ to select the parameter to be set.
- 7) If you are finished setting parameters, press the Reset Button ⑪, then turn the Main Power Switch ⑨ OFF.

20-3-7 Setting of Motor Acceleration Time and Deceleration Time

- Sets the time from the Motor start-up until reaching the maximum Motor speed, and the Deceleration Time from the maximum Motor speed to stop.
- Acceleration Time and Deceleration Time are common.











Procedure

- 1) Push the Start Button .
- 2)  is displayed. In this setting, the Acceleration Time and Deceleration Time is 2 seconds, which is the factory default time setting.
- 3) Push the Start Button .
- 4)  is displayed. This indicates that the Acceleration Time and Deceleration Time can be set.
- 5) The Digital Speed Indicator  will oscillate between  and the Acceleration Time/Deceleration time. Longer Accel/Decel time can be selected by pushing the Motor Speed Adjustment Button .
- 6) Push the Reset Button  to send the settings to memory,  will be displayed depending on the parameter being set.
- 7) If you desire to set other parameters push the Motor Speed Adjustment Button  to select the parameter to be set.
- 8) If you are finished setting parameters, press the Reset Button , then turn the Main Power Switch  OFF.

20-3-8 Setting Emergency Stop Feature

- The Emergency Stop feature is activated with this parameter.
- Motor rotation is stopped by an Emergency Stop Signal.











Procedure

- 1) Push the Start/Stop Button .
- 2)  is displayed. This indicates that Emergency Signal (Input/Output Connector B Pin No. 1 : EMGIN-A and Pin No. 9 : EMGIN-B) can not be used.
- 3) Push the Start/Stop Button .
- 4)  is displayed. This indicates that Emergency Signal can be used.
- 5) You can cycle through the choices by pushing the Start/Stop Button .
- 6) Push the Reset Button  to send the settings to memory,  will be displayed depending on the parameter being set.
- 7) If you desire to set other parameters push the Motor Speed Adjustment Button  to select the parameter to be set.
- 8) If you are finished setting parameters, press the Reset Button , then turn the Main Power Switch  OFF.

20-3-9 Setting Speed Achievement Level

- A predetermined At-Speed (Spindle Arrival Percentage Time) can be set by in P9 and is output to Pin 21.
- By selecting the percentage of time from 50% to 100%. Speed Achievement is used to make sure that the Spindle is close to full speed before cutting occurs. The preset value from the factory is 90%.

Procedure

- 1) Push the Start/Stop Button .
- 2)  appears on the indicator. With this setting Speed Achievement Level is 90%, which is the factory default percentage.
- 3) Push the Start/Stop Button .
- 4)  appears on the indicator. Speed Achievement Level appears on the indicator.
- 5) The display unit is in percentage of the set speed.
- 6) Select the level you want to set with the Motor Speed Adjustment Button  range of speed achievement ratio 50~100%.
- 7) Push the Reset Button  to send the settings to memory,  will be displayed depending on the parameter being set.
- 8) If you desire to set other parameters, push the Motor Speed Adjustment Button  to select the parameter to be set.
- 9) If you are finished setting parameters, press the Reset Button , then turn the Main Power Switch  OFF.

20-3-10 Error History P 10

- Displays previous errors recorded in the control. The control is capable of storing the last 5 Error Codes that were displayed. The errors are stored with archive numbers from 1 to 5.
The latest Error Code recorded will be No.1 and the oldest will be No.5. This feature is used to view alarms when no one was present at the time of the error. Use the Motor Speed Adjustment Button 5 to scroll through the alarms. If no errors are present, " --- " will be displayed when viewing P 10.

Procedure

- 1) Push the Start/Stop button 6.
- 2) The newest Error Code is shown on the display when there is an Error History.
If the Error Code is memorized, the error history number and the Error Code are shown on the display.
- 3) The Error History is sequentially displayed by pushing the "Motor Speed Adjustment Button 5".
Error NO. 5 is the oldest error message and No. 1 is the newest error message.
- 4) In case there is no Error History --- will be displayed.
- 5) Push the Reset Button 11.
- 6) If you desire to set other parameters, push the Motor Speed Adjustment Button 5 to select the parameter to be set.
- 7) If you are finished setting parameters, press the Reset Button 11, then turn the Main Power Switch 9 OFF.

20-3-11 Confirmation of the Parameter Settings P 11

- Allows the user to check the settings of the above parameters P 11 - P 10

Procedure

- 1) Push the Start/Stop Button 6.
- 2) Display oscillates between P 11 and the setting for off or on.
- 3) Push the Motor Speed Adjustment Button 5.
- 4) Display oscillates between P 2 and the setting for off or on.
- 5) Push the Motor Speed Adjustment Button 5.
- 6) Display oscillates between P 3 and the setting for off or on.
- 7) on is showed on display when motor speed of Motor No. 1 or No. 2 is set.
- 8) Push the Motor Speed Adjustment Button 5.
- 9) Display oscillates between P 4 and the setting for off or on.
- 10) on is showed on display when maximum speed of Motor No. 1 or No. 2 is set.
- 11) Push the Motor Speed Adjustment Button 5.
- 12) Display oscillates between P 5 and the setting for An, en or Pe
- 13) Push the Motor Speed Adjustment Button 5.
- 14) Display oscillates between P 6 and the setting for off or on
- 15) Push the Motor Speed Adjustment Button 5.
- 16) Display oscillates between P 7 and the setting for off or on
- 17) Push the Motor Speed Adjustment Button 5.
- 18) Display oscillates between P 8 and the setting for off or on
- 19) Push the Motor Speed Adjustment Button 5.
- 20) Display oscillates between P 9 and the setting for off or on
- 21) Push the Motor Speed Adjustment Button 5.
- 22) Display oscillates between P 10 and the setting for off or on
- 23) Push the Motor Speed Adjustment Button 5.
- 24) Push the Reset Button 11.
- 25) If you desire to set other parameters, push the Motor Speed Adjustment Button 5 to select the parameter to be set.
- 26) If you are finished setting parameters, press the Reset Button 11, then turn the Main Power Switch 9 OFF.

20-4 Default Parameter Settings

* When the system is shipped from NAKANISHI's factory, all parameters.

- are set to (is set to)

20-5 Control Panel Setting Resume Function

On power up the system will resume all the control panel settings in the position they were in when the Control Unit was Powered OFF.

The following settings will be maintained

- 1) Motor Speed (Motor No. 1 or Motor No. 2)
- 2) Rotating Direction (FWD., REV.).
- 3) Control Mode (AUTO, MANUAL).
- 4) Motor Channel (No.1, No.2).
- 5) Display Mode.
- 6) Parameter Settings -
- 7) Key Hold

21. TROUBLE SHOOTING

Table 8

Trouble	Cause	Inspect/Corrective Action
Motor Does Not Run.	Power is not supplied.	<ul style="list-style-type: none"> • Check to the main power inlet connection on the rear of the control unit. • Insert the power plug correctly. • Check if the fuse is blown.
	Incompatible Motor is connected to the control unit.	Connect the motor spindle that can be connected to the control unit. Refer to section 4 "SYSTEM CHART" Fig. 2.
	Controller Button is set to manual but trying to start with an external command signal through Input/Output Connector A (A).	Start the motor spindle with the Start/Stop Button (6) on the control panel, or set the CTRL Button (9) to Auto.
	Controller Button is set to Auto but trying to start with the Start/Stop Button (6) on the control panel.	Start with an External Command Signal or set the CTRL Button (9) to Manual.
	Motor Cord or connector is disconnected.	Re-connect the motor cord, check the connector and check the motor cord.
	Emergency Stop Signal on Input/Output Connector B(B) is OFF (Open). (Only when the parameter P 8 is set to on.)	Set Emergency Stop Signal to be "ON" (close).
	Error Code Indicated.	Check this Operation Manual for the source of the error code (Table 7).
	Low Air Pressure.	Refer to section 6-2 "1 SETTING AIR PRESSURE".
	The Start/Stop Button is not activated because Key Hold is set.	Release the Key Hold.
Motor speed is not displayed correctly.	Motor Fixed Speed is set in the P 3 parameter.	Check the setting parameter and adjust as required.
	Motor Maximum Speed is set in the P 4 parameter.	
High Run-Out.	Foreign particles stuck in the collet chuck or Spindle.	Clean the inside of the collet chuck, chuck nut and spindle.
	Collet nut is not correctly installed.	Position the chuck nut correctly.
	Ball bearings are worn.	Return to NAKANISHI dealer service.
Abnormal Vibration or noise during spindle rotation.	Foreign particles in the ball bearings. Ball bearings are worn.	Return to NAKANISHI dealer service.
	Tool out of balance.	Replace the tool.

※Specifications may be changed without notice.

NAKANISHI INC. 
www.nakanishi-inc.com

700 Shimohinata Kanuma-shi
Tochigi 322-8666,
Japan

NSK Europe GmbH 
www.nsk-europe.de

Elly-Beinhorn-Strasse 8
65760 Eschborn,
Germany

NSK America Corp
www.nskamericacorp.com

1800 Global Parkway
Hoffman Estates, IL 60192,
USA

'11.10.005 ©