

**超音波研磨装置 / UltraSonic Polisher**

# ***SHEENUS neo***

**取扱説明書 / OPERATION MANUAL**

OM-K0517 001

**目 次**

1. 安全上の注意・表示について	P 2
2. 仕様	P 3
3. 各部の名称	P 4
4. 使用前の準備	P 6
5. 工具の交換方法	P 7
6. 操作方法	P 8
7. 保護回路について	P 9
8. 超音波仕上げ作業の要点	P 9
9. ヒューズの交換方法	P10
10. 操作パネルの設定方法	P11
11. シンボル	P11
12. テストホーンを使用した簡易的な振動確認方法	P12
13. 故障の原因と対策	P13

**CONTENTS**

1. CAUTIONS FOR HANDLING AND OPERATION	P16
2. SPECIFICATIONS AND DIMENSIONS	P18
3. COMPONENT NAMES	P18
4. PREPARATION BEFORE USE	P22
5. ATTACHMENT OF THE TOOL	P23
6. OPERATING PROCEDURES	P24
7. PROTECTION CIRCUIT	P24
8. FINISHING OPERATION BY ULTRASONIC POLISHER	P25
9. CHANGING FUSES	P26
10. HOW TO SET THE CONTROL UNIT	P27
11. SYMBOLS	P27
12. SIMPLE TEST METHOD USING THE TEST HORN	P28
13. TROUBLESHOOTING	P29

Thank you for purchasing the Ultrasonic Polisher SHEENUS neo. This product is designed for grinding, polishing, and mirror finishing on a wide range of materials from aluminum dies to cemented carbide dies. And has a wide variety of finishing tools such as diamond stone, diamond file, ceramic stone and wooden lapping tools. Read this Operation Manual carefully before use.

## 1. CAUTIONS FOR HANDLING AND OPERATION

- Please read the operation manual thoroughly, make sure you understand all warnings and cautions prior to operating the system and only use the system in the manner intended.
- These warnings and cautions are intended to avoid potential hazards that could result in personal injury or damage to the device. These are classified as follows in accordance with the seriousness of the risk.

Class	Degree of Risk
⚠ <b>WARNING</b>	<b>A hazard that could result in bodily injury or damage to the device if the safety instructions are not properly followed.</b>
⚠ <b>CAUTION</b>	<b>A hazard that could result in light or moderate bodily injury or damage to the device if the safety instructions are not followed.</b>
⚠ <b>INFORMATION</b>	<b>Be sure to keep the usage for your safety.</b>

### A. GROUNDING INSTRUCTIONS

- ① In the event of a malfunction or breakdown, grounding provides a path of least resistance for electric current to reduce the risk of electric shock. This tool is equipped with a power cord having an equipment grounding conductor and a grounding plug. The plug must be plugged into a matching outlet that is properly installed and grounded in accordance with all local codes and ordinances.
- ② Do not modify the plug provided-if it will not fit the outlet, have the proper outlet installed by a qualified electrician.
- ③ Improper connection of the equipment-grounding conductor can result in a risk of electric shock. The conductor with insulation having an outer surface that is green with or without yellow stripes is the equipment grounding conductor. If repair or replacement of the power cord or plug is necessary, do not connect the equipment-grounding conductor to a live terminal.
- ④ Check with a qualified electrician or service personnel if the grounding instructions are not completely understood, or if in doubt as to whether the tool is properly grounded.
- ⑤ Use only 3-wire extension cords that have 3-prong grounding plugs and 3-pole receptacles that accept the tool's plug.
- ⑥ (120V) This tool is intended for use on a circuit that has an outlet that looks like the one illustrated in Sketch A in Figure (below). The tool has a grounding plug that looks like the plug illustrated in Sketch A in Figure (below). A temporary adapter, which looks like the adapter illustrated in Sketches B and C, may be used to connect this plug to a 2-pole receptacle as shown in Sketch B if a properly grounded outlet is not available. The temporary adapter should be used only until a properly grounded outlet can be installed by a qualified electrician. The green-colored rigid ear, lug, and the like, extending from the adapter must be connected to a permanent ground such as a properly grounded outlet box.  
NOTE: Adapter in (Figure B) is not for use in Canada.
- ⑦ Return to NAKANISHI dealer service for servicing / repair.

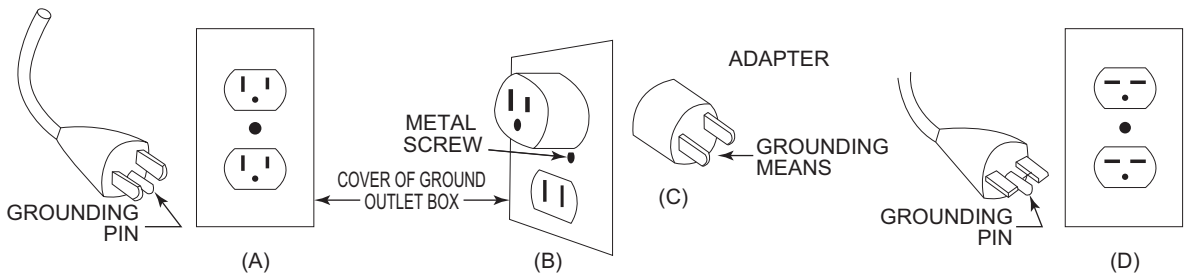

- ⑧ **Use proper extension cord. Make sure your extension cord is in good condition. When using an extension cord, be sure to use one heavy enough to carry the current your product will draw. An undersized cord will cause a drop in line voltage resulting in loss of power and overheating. Table (below) indicates the correct size to use depending on cord length and nameplate ampere rating. If in doubt, use the next heavier gauge. The smaller the gauge number, the heavier the cord.**

Ampere Rating		Volts	Total length of cord			
			7.5m (25ft.)	15m (50ft.)	30m (100ft.)	45m (150ft.)
		120V	7.5m (25ft.)	15m (50ft.)	30m (100ft.)	45m (150ft.)
		240V	15m (50ft.)	30m (100ft.)	60m (200ft.)	90m (300ft.)
More Than	Not More Than					
0	6		18	16	16	14
6	10		18	16	14	12
10	12		16	16	14	12
12	16		14	12	Not Recommended	

Only the applicable parts of the Table need to be included. For instance, a 120-volt product need include the 240-volt heading.

## B. WARNING

- ① **Always wear safety glasses. Everyday eyeglasses only have impact resistant lenses, they are not safety glasses. Also use a dust or face mask whenever the system is operating.**
- ② **Make sure to connect the earth cables to ground before use.**
- ③ **Do not use near flammable substances or in explosive atmospheres. Contact with flammable substances while the system is operating may cause a fire.**
- ④ **Do not use in dangerous environments. Protect the Control Unit from moisture, dust, corrosive gasses, near chloride vapors, and out of direct sunlight. All of which can cause pre-mature failure. Failure to protect the Control Unit can result in damage to internal components and result in injury to the operator.**
- ⑤ **Ultrasonic vibration may cause noise during use. Earplugs or ear protection is recommended.**
- ⑥ **Never place the air vents upward or block the air vents in the rear/bottom of the Control Unit when in use.**
- ⑦ **Contamination or scratches on the tool thread, the Handpiece or the ultrasonic horn may cause abnormal vibration or overheat.**
- ⑧ **Attach the tool firmly to the ultrasonic horn. If the tool is not attached firmly, the power would go down or the hanpiece would overheat.**
- ⑨ **The tool or the tip holder may heat up due to ultrasonic vibration even though under normal conditions. Holding them tightly or pressing against the skin may cause a burn.**
- ⑩ **Do not hit, disassemble, modify or attempt to repair the control unit and or Handpiece. Additional damage will occur to the internal components. If the control unit is disassembled, electric shock may occur from high voltage areas on internal circuit boards. If the Control Unit is tampered with, warranties may be voided. Service must be performed by NSK NAKANISHI or an authorized service center.**
- ⑪ **Protect the Handpiece from oils and liquids. This may cause premature hand-piece failure. Do not spray cutting oil or lubricants on the Handpiece.**
- ⑫ **Do not touch the tool, tip holder or ultrasonic horn while the system is operating. The components and tools may be very hot and cause injury.**

## C. CAUTION

- ① Use at room temperature (10 degrees C to 40 degrees C) with no appreciable humidity. Failure to follow this may cause a short circuit or electric shock.
- ② Check the operating conditions before use. If any abnormality is found, return to the dealer where you purchased the Sheenus neo for repair.
- ③ When installing the control unit, provide space of approximately 10cm around the control unit for easy access to the plug of power cord in case of emergency.
- ④ If tools, tip holder or the Handpiece get hot and/or the pitch of the noise changes suddenly during use, stop immediately and check all components. If the tool is broken, do not continue to use the tool. Replace with a new tool immediately.
- ⑤ The system functions normally in the environment where the temperature is at 10 - 40°C (75 - 104°F), humidity at 30 - 75% RH, and with no moisture or condensation near the Control Unit. Usage outside of this recommended range may cause a malfunction.
- ⑥ Store the system in the place where the temperature is at -10 - 50°C (14 - 140°F), humidity at 10 - 85%RH, atmospheric pressure at 500 - 1060hPa, Store the unit where it will not be subject to air with dust, sulfur, or salinity.

## D. INFORMATION

- ① Be sure to only use with Power Supply Cord of the standard accessories.  
Using a non-specified Power Supply Cord, the risk of fire by over-heating of the cord is possible. If damage to the Power Supply Cord, return to NAKANISHI dealer service for servicing / repair.
- ② This product utilizes an ultrasonic transmitter. It may affect computers and LAN cables nearby. Also radio receivers may pick up noise.
- ③ Turn OFF the Main Power Switch after use. If you do not use for a long time, unplug of the power cord.
- ④ Users are responsible for safe operation and maintenance.

## 2. SPECIFICATIONS AND DIMENSIONS

### 2 - 1 Control Unit

Model	NE240
Oscillation frequency	22.5KHz
Frequency Control	Homing Type
Output	45W max. (UNCLAMP MODE)
	20W max. (CLAMP MODE)
Power Conditioning	Continuous variable type
Power Source	AC120V, 50 / 60Hz AC230V, 50 / 60Hz
Rating Input	55VA
Appropriate fuse	AC120V : T1.6AH 250V AC230V : T1AH 250V
Dimensions	W225 × D195 × H97mm
Weight	2.1 kg

## 2 - 2 Handpiece

Model	US-25PB
Oscillator	PZT piezoelectric type
Cord length	2m
Weight	140g (excluding cord)

## 2 - 3 Standard Accessories

Standard Accessories	
<ul style="list-style-type: none"> <li>• Power Cord (2m) • • 1pc.</li> <li>• Wrench (10mm) • • 2pc.</li> <li>• Fuses For AC120V...T1.6AH 250V ...2pcs. For AC230V...T1AH 250V ...2pcs.</li> </ul>	<ul style="list-style-type: none"> <li>• Foot Switch (FC-24) • • 1pc.</li> <li>• Allen Wrench (2.5mm) • • 1pc.</li> <li>• Tool Case • • 1pc.</li> <li>• Handpiece Stand • • 1pc.</li> </ul>
Standard Tools	
<ul style="list-style-type: none"> <li>• Tip holder (Round for <math>\phi</math> 3.0mm) • • 1pc.</li> <li>• Tip holder (Flat for t = 1.0mm) • • 1pc.</li> <li>• Ceramic fiber grindstone #800 (Flat 6 × 50mm t = 1) • • 1pc.</li> <li>• Electroplated diamond file #200 (Flat taper 4 × 50mm t = 0.4) • • 1pc.</li> </ul>	

## 3. COMPONENT NAMES

### 3 - 1 Standard Set



Fig. 1

- ① Control Unit (NE240)
- ② Handpiece (US-25PB)
- ③ Foot Switch (FC-24)

### 3 - 2 Front of Control Unit (NE240)

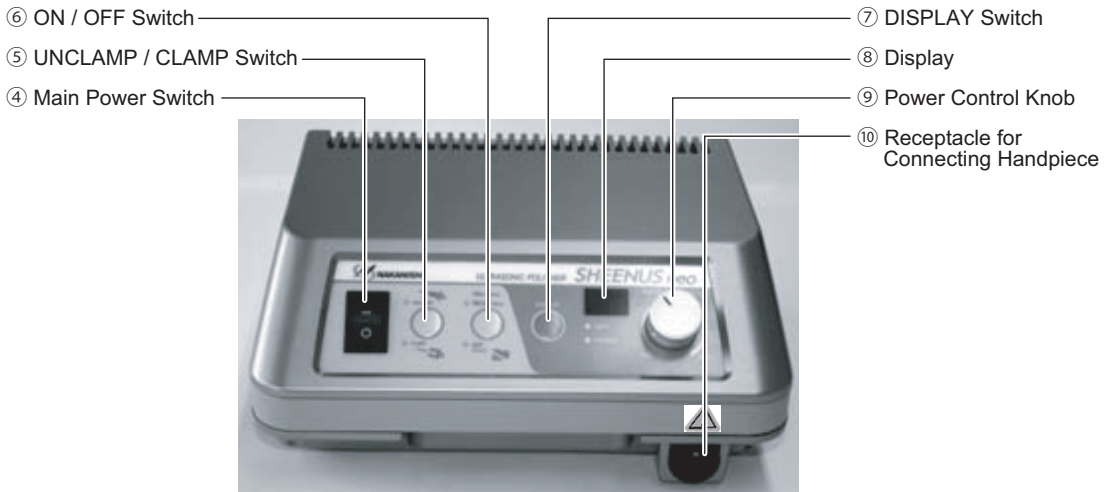













Fig.2

- ④ Main Power Switch  
ON / OFF Main Power Source. The designation " I " indicates ON. The designation " O " indicates OFF.
- ⑤ UNCLAMP (  ) / CLAMP (  ) Switch  
This switch will change the UNCLAMP mode (  ) or CLAMP mode (  ).
  - UNCLAMP mode (  )  
When using a One-Piece tool, set to the UNCLAMP mode (  ).
  - CLAMP mode (  )  
When using the tip holder (manually mounted tips) and M4 Screw Joint Adapter, set the unit to the CLAMP mode (  ). When using the tip holder (files) or the M4 Screw Joint Adapter (the M4 one-piece tools mounted) and setting to the unit to UNCLAMP mode (  ), excessive vibration and heat will damage the Handpiece ② and or Control Unit ①.
- ⑥ ON / OFF Switch  
This is to turn Control Unit power or OFF. The ON LED lamp (GREEN) is on at start up and during normal operation the OFF LED lamp (GREEN) is when shutdown. When the CLAMP protection circuit stops the Control Unit ①, the RESET LED lamp (RED) lights up and the Control Unit ① will need to be restarted by pressing the RESET Switch twice after correcting the problem.
- ⑦ DISPLAY Switch  
By pressing the DISPLAY Switch ⑦, the LED display can be changed from Watt / Power.
- ⑧ DISPLAY  
The selected Watt / Power value is shown on the display.  
WATT : Electric power supplied to the oscillator is shown.  
The heat generated in the Handpiece ②, tip holder and tool is proportional to the power applied to the oscillator, too much power will cause the Handpiece ②, tip holder and tool to overheat and possibly burn. If the Handpiece ②, tip holder or tool becomes hot, lower the power setting. Use great care to avoid touching the tip holder and tool during working as they can cause severe burns.  
POWER : Output level is shown.  
Applicable display range is 0 - 49. (with the test tool, UNCLAMP mode (  ) is 19 - 49, CLAMP mode (  ) is 8 - 23.)
- ⑨ Power Control Knob  
Turn the Power Control Knob ⑨ to control the output.
- ⑩ Receptacle for Connecting Handpiece  
Connect the plug of Handpiece Cord.

### 3 - 3 Rear of Control Unit

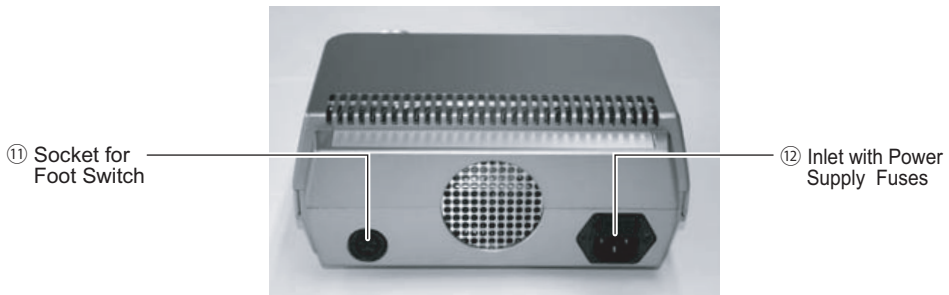

Fig. 3

①① Socket for Foot Switch

Connect the Plug of Foot Switch ③.

①② Inlet with Power Supply Fuses

Insert the Power Cord here.

Two Fuses are possible (for AC120V : T1.6AH, for AC230V···T1AH 250V). Verify and use only the properly rated and type fuses.

### 3 - 4 Handpiece (US-25PB)

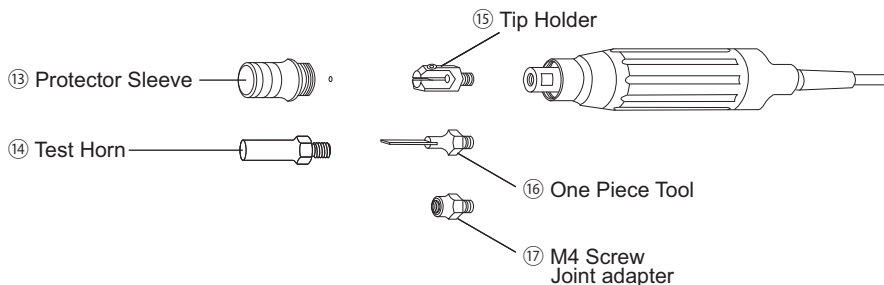

Fig. 4

①③ Protector Sleeve

The Protector Sleeve ⑬ is to protect hands from touching the heated tool joint. If using the Handpiece ② without attaching the Protector Sleeve ⑬, burn injuries can occur. Always attach the Protector Sleeve to the Handpiece ②.

①④ Test Horn

When you unpack the carton, the Test Horn ⑭ is attached to the front end of Handpiece ②.

The Test Horn ⑭ is used to verify that the Handpiece ② is correctly generating the ultrasonic oscillation for normal operation.

When using the Handpiece ②, remove the Test Horn ⑭ from the Handpiece ②.

①⑤ Tip Holder

Holder to attach special tip tools.

①⑥ One-Piece Tool

M-6 one-piece tools can be used directly attached to the Handpiece ②. When using M4 one-piece tools, attach the tool to the M4 Screw Joint Adapter and then attach to the Handpiece ②.

①⑦ M4 Screw Joint Adapter

M4 Screw Joint Adapter is used to attach an M4 one-piece tool to the Handpiece ②.

## 4. PREPARATION BEFORE USE

- (1) The Test Horn ⑭ comes with the Handpiece ② . Remove the Protector Sleeve ⑬ and unscrew the Test Horn ⑭ using the two wrenches provided.



Fig. 5

- (2) Insert the output plug of the Hand-piece into the Receptacle for Connecting Handpiece ⑩ to the Control Unit ① .

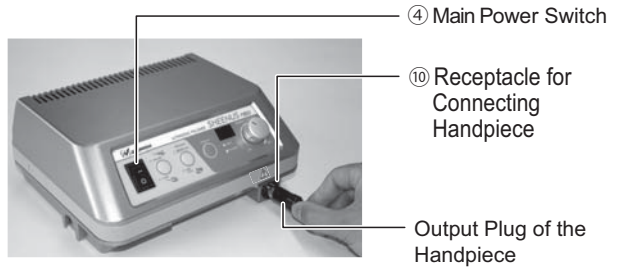

Fig. 6

- (3) Make sure that the Main Power Switch ④ is OFF, and connect the power cord to the Inlet with Power Supply Fuses ⑫ of the Control Unit ① .

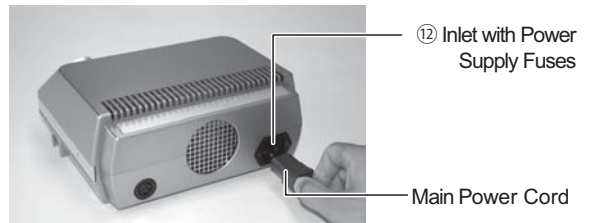

Fig. 7

- (4) When using the Foot Switch ③, connect the Plug of the Foot Switch to the Socket for Foot Switch ⑪ .

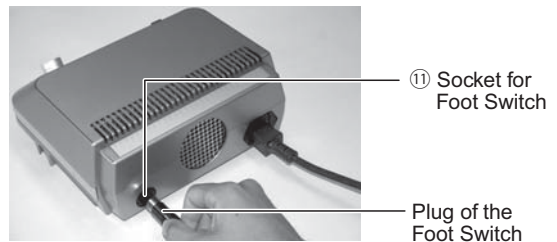

Fig. 8



## 5. ATTACHMENT OF THE TOOL

### 5 - 1 Attachment of One-Piece Tools ⑯, Tip Holders ⑮ and M4 Screw Joint Adapter ⑰

Attach the Tip Holders ⑮ or the M4 Screw Joint Adapter ⑰ to the Handpiece ② and clamp tightly using two provided wrenches. (Fig. 9).

Then reattach the Protector Sleeve ⑬ .

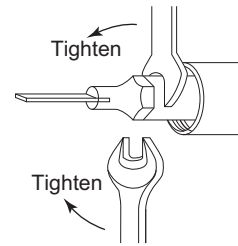

Fig. 9

### 5 - 2 Attachment of Tip tools (e.g. ceramic grind stone tip)

Insert the grind stone tip to the Tip Holder ⑮ and tighten the screw using the provided Allen Wrench (2.5mm). If the clearance between the groove of the Tip Holders ⑮ and the tool is too large, do not use excess force to tighten. Use a thin metal shim. Reattach the Protector Sleeve ⑬ .

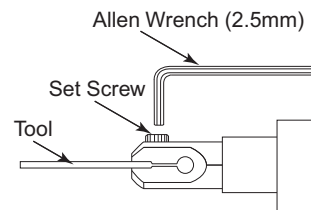

Fig. 10

### 5 - 3 M4 Screw Joint Adapter



Attach the M4 Screw Joint Adapter ⑰ to the Handpiece ② and clamp tightly using the two provided wrenches. Then attach the M4 One-piece tool and clamp using the provided wrenches, then reattach the Protector Sleeve ⑬ .







### Caution on attaching the tool

If the tool or the Tip Holder ⑮ is loose, oscillation will be weak and cause noise or overheating.

## 6. OPERATING PROCEDURES

- (1) Turn ON the Main Power Switch ④ and make sure the Display ⑧ appears.
- (2) Select UNCLAMP / CLAMP mode using the UNCLAMP / CLAMP Switch ⑤ .  
The UNCLAMP mode (  ) or CLAMP mode (  ) LED will illuminate green.

### ⚠ CAUTION

- Use CLAMP mode (  ) for the Tip Holders ⑮.
- Use CLAMP mode (  ) for the M4 Screw Joint Adaptor ⑰.
- Use UNCLAMP mode (  ) for One-Piece Tools ⑯ (for M6).
- The screw size of the One-Piece Tools ⑯ is M6 x 0.9. Do not use different sized screws.
- Never remove or attach the plug of Handpiece ② or the plug of Foot Switch while depressing the Foot Switch ③. Failure to follow this warning may result in an error code or damage to the Control Unit ①.
- Please use a maximum of 8W of electric power when in continuous operation.
- Do not use Tip Holders ⑮ with the Control Unit ① set in UNCLAMP mode (  ). Use CLAMP mode (  ) for clamped tools.
- Using tools at too high a power setting can cause the tools and Tip Holders ⑮ to get extremely hot and damage the Handpiece ② and Control Unit ①, causing tools to burn and cause injuries.

- (3) Set the Power Control Knob ⑨ to a minimum setting.
- (4) Press the ON / OFF Switch ⑥. ON LED lamp will light up GREEN.  
\* When operating by the Foot Switch ③, the ON LED lamp will light up by pressing the Foot Switch ③.
- (5) The display screen "WATT" "POWER" can be changed by pressing the DISPLAY Switch ⑦.
- (6) Adjust output power to the optimum level for the work by turning the Power Control Knob ⑨ clockwise.
- (7) Press the ON / OFF Switch ⑥ again to stop. The OFF LED lamp will light up green and stop the operation.  
\* When operating by the Foot Switch ③, releasing the Foot Switch ③ will stop the operation.
- (8) Make sure to turn OFF the Main Power Switch ④ after use.

- ⑥ ON / OFF Switch
- ⑤ UNCLAMP / CLAMP Switch
- ④ Main Power Switch
- ⑦ DISPLAY Switch
- ⑧ DISPLAY
- ⑨ Power Control Knob



Fig. 11

## 7. PROTECTION CIRCUIT

- (1) Protection System  
The RESET LED lamp (RED) will illuminate and the operation will stop automatically in the following situations.
  - Too much pressure on the tool.
  - The tool is not clamped properly.
  - The tool is likely broke or the brazing on the tool is loose.
  - The internal temperature in the Control Unit ① is too high.

(2) How to release the protection circuit

Resolve the problem that caused the protection circuit to activate. Release the protection circuit by taking the following actions.

- When operating by the ON/OFF Switch ⑥ .  
Toggle the ON/OFF Switch ⑥ . The RESET LED (RED) will be turned OFF and the protection circuit will be released.
- When operating by the Foot Switch ③.  
Release the Foot Switch ③ . The RESET LED lamp (RED) will be turned OFF and the protection circuit will be released.
- \* When "01" is set for the Foot Switch ③ change (refer to "11. HOW TO SET THE CONTROL UNIT" section), press the Foot Switch ③ or toggle the ON/OFF Switch ⑥ . The RESET LED (RED) will be turned OFF and the protection circuit will be released.

## 8. FINISHING OPERATION BY ULTRASONIC POLISHER

(1) Basic usage

The best method for using ultrasonic polishers is to press with slight pressure and keep the tools moving over the surface of the work material. The figures below show the direction of the ultrasonic vibration and the most effective direction to move the tool over the work surface. Ultrasonic vibration greatly reduces the pressure required for fast material removal. Do not press the tool too hard and make sure the tool fits the surface configuration properly. If required, you can grind the tool surface to the proper shape using diamond tools or sand paper.

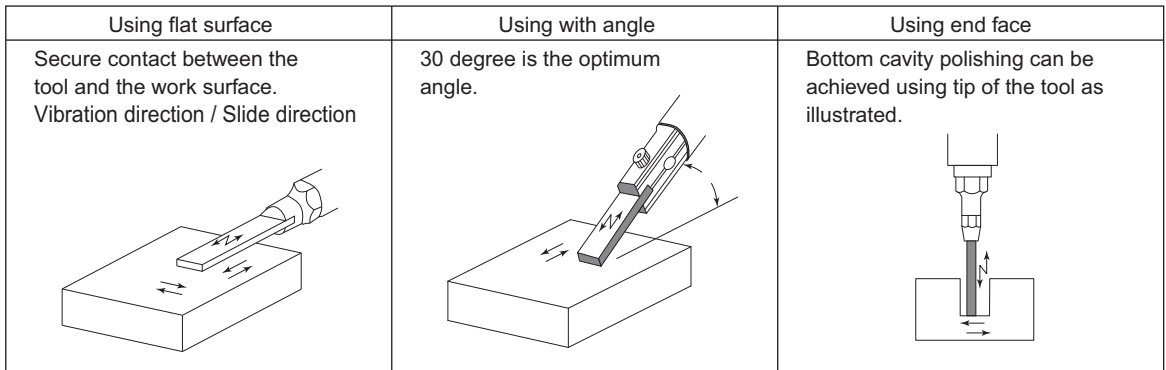



Fig. 12

(2) SHEENUS neo tool length specifications

Please refer to the following table as a guideline to find the proper tool length. The length listed in the chart is the length of the tool prior to mounting into the Tip Holders ⑮ . Check to make sure that the tool is properly clamped in the holder and that the holder is tightly fastened to the ultrasonic horn prior to operating the system.

Special tools for SHEENUS neo	Dimensions (mm)	Appropriate length (mm)
Ceramic Fiber Grindstone	4 × 0.8 6 × 0.8	50 - 10
	4 × 1.0 6 × 1.0	
	φ 3	50 - 10

(3) Wood or brass lapping tips usage

When using wood or brass lapping tips select CLAMP mode (  ) and start at a very low power setting. If too much power is applied the protection circuit will activate and stop the Control Unit ① .

## 9. CHANGING FUSES

### WARNING

- Make sure to turn OFF the Main power switch ④ and remove the power cord from the Inlet with power supply fuses ⑫ before replacing the fuse.
- Use intended fuse only.

Recommended fuses : AC120V : T1.6AH 250V  
AC230V : T1AH 250V

- (1) The Inlet with power supply fuses ⑫ contains a fuse box inside. Push the clips on both side of the cap in and pull the cap out.
- (2) Use the intended fuse only. Replace both of the fuses when replacing the fuses.
- (3) Push the clips of the cap into the inlet firmly.

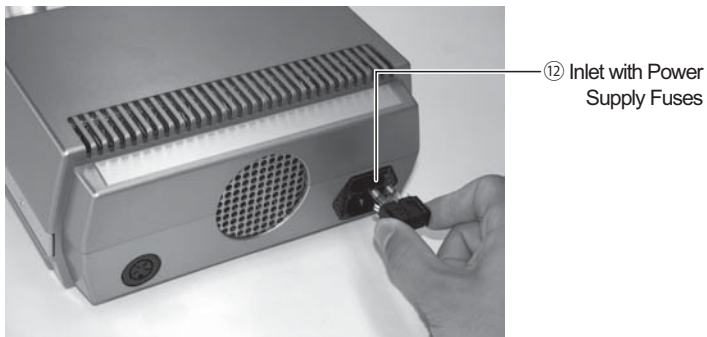

Fig. 13

## 10. HOW TO SET THE CONTROL UNIT

- (1) Changing Watt display (0W display ⇒ 0.0W display)
  - Turn OFF the Main Power Switch ④ .
  - Turn ON the Main Power Switch ④ while pressing the UNCLAMP / CLAMP Switch ⑤.
  - The DISPLAY ⑧ shows WATT and 0.0 appears on the screen.
  - Turn OFF the Main Power Switch ④ and the setting is stored and completed.
  - If you would prefer integral number, follow the same procedure again. The initial setting is 0.
- (2) Alter the Foot Switch ③ operation

The Foot Switch ③ operation can be changed by Pressing-ON, Release-OFF operation to Press-ON, Press-OFF again.

  - Turn OFF the Main Power Switch ④ .
  - Turn ON the Main Power Switch ④ while pressing the ON/OFF Switch ⑥.
  - The DISPLAY ⑧ shows 00 (or 01). Press the ON/OFF Switch ⑥ again and select 01 (or 00).
    - 00 display: Press the Foot Switch ③ to start, release the Foot Switch ③ to stop.
    - 01 display: Press the Foot Switch ③ to start, press the Foot Switch ③ again to stop.
  - Turn OFF the Main Power Switch ④ and the setting is completed. The initial setting is 00.
- (3) Changing the non-use auto shutdown time

The Control Unit ① is equipped with a non-use auto shutdown timer that will shutdown the Control Unit ① after extended periods of non-use. The default time is factory set to 3 minutes.

  - Turn OFF the Main Power Switch ④.
  - Turn ON the Main Power Switch ④ with pressing the DISPLAY Switch ⑦.
  - The DISPLAY ⑧ shows 03. Press the DISPLAY Switch ⑦ and select the time.

00 : Not available	01 : Turn OFF in 1 minute
02 : Turn OFF in 2 minutes	03 : Turn OFF in 3 minutes
05 : Turn OFF in 5 minutes	10 : Turn OFF in 10 minutes
  - Turn OFF the Main Power Switch ④ and the setting is complete.

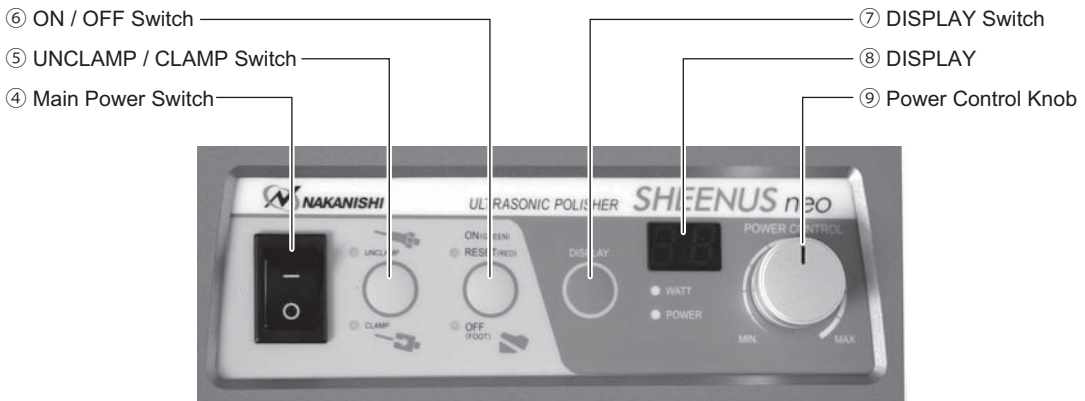





Fig. 14

## 11. SYMBOLS

- Ⓒ This product has been tested to the requirements of CAN/CSA-C22.2 No. 61010-1, second edition, including Amendment 1, or a later version of the same standard incorporating the same level of testing requirements.
- CE This conforms to CE European Directive of "Machinery Directive 2006 / 42 / EC."
- ⚠ Hot surface. Do not touch.
- ⚠ This mark is a warning, caution and, or information. These are intended to avoid potential hazards that could result in personal injury or damage to the product.

## 12. SIMPLE TEST METHOD USING THE TEST HORN

- (1) Mount the Test Horn ⑭ securely on the Handpiece ②.
- (2) Set the UNCLAMP (  ) / CLAMP (  ) Switch ⑤ to UNCLAMP mode (  ), and the Power Control Knob ⑨ to MIN.
- (3) Put a drop of water on the Test Horn ⑭ (Fig. 15).

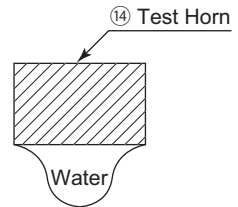

Fig. 15

- (4) Turn ON the output ON / OFF Switch ⑥, keeping the Power Control Knob ⑨ at MIN.  
Ultra sonic oscillation draws the water drop flat as shown on the Test Horn ⑭ (Fig. 16).

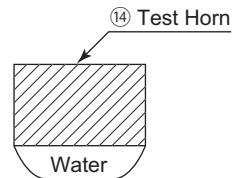

Fig. 16

- (5) As you gradually increase the Power Control Knob ⑨ to MAX, the water drop on the Test Horn ⑭ become vapor as shown Fig. 17.

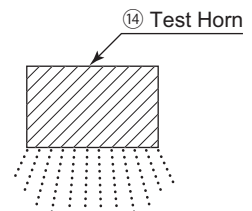







Fig. 17

In case oscillation is not output, or sufficient mist cannot be generated in the UNCLAMP mode (  ), check if the Test Horn ⑭ is not tightly mounted on the Handpiece ②. Retighten it and repeat above test.  
If the condition does not improve, return to NAKANISHI dealer service.

## 13. TROUBLESHOOTING

If a problem or concern occurs, please check the following prior to consulting your dealer.

Problem	Item to be checked	Possible cause	Countermeasure
Not vibrate.	DISPLAY ⑧ not light up.	The Plug of Power Cord is not inserted.	Insert the plug of Power Cord.
		The Main Power Switch ④ is OFF.	Turn on the Main Power Switch ④.
		The Power Cord is broken.	Replace the Power Cord.
		The Main Power Switch ④ is defective.	Return to a NAKANISHI dealer for service.
		The fuse is blown.	Replace the fuse. If the replaced fuse is blown again, contact your local Nakanishi dealer.
	ON LED does not light up GREEN.	The ON / OFF Switch ⑥ is OFF.	Turn ON the ON / OFF Switch ⑥.
		The plug of Handpiece is not properly connected to the Receptacle for Connecting Handpiece ⑩ .	Connect the plug of Handpiece properly.
		The Foot Switch ③ is defective.	Return to a NAKANISHI dealer for service.
		The output cord is broken.	
	ON LED lights up GREEN.	The ultrasonic oscillator or the Control Unit ① is defective.	
Vibration stops during operation.	RESET LED lights up RED.	Too much pressure on the tool and the protection system activated.	Do not put too much pressure on the tool.
		The Power Control Knob ⑨ is set too high.	Adjust the Power Control Knob ⑨ to a lower setting and restart.
		The thermal protector is activated when in continuous operation.	Turn OFF the Main Power Switch ④ and the system to cool down.
		The tool has become loose.	Re-tighten the tool.
		The tool is broken or bent.	Replace or straighten the tool.
Vibration is low.	ON LED lights up GREEN.	Non-standard tool is used.	Replace the tool.
		The tool is not tightened properly.	Tighten the tool.
		The Power Control Knob ⑨ is set too low.	Adjust the output power to the optimum level for the work.
		CLAMP mode (  ) is set.	Change the setting to UNCLAMP mode (  ).
Abnormal noise or sudden heat rise is generated.	ON LED or RESET LED lights up.	The tool has become loose.	Clamp the tool.
		The tool is broken or bent.	Replace the tool.
		Non-standard tool is used.	Replace the tool.

Problem	Item to be checked	Possible cause	Countermeasure
Abnormal noise or sudden heat rise is generated.	ON LED or RESET LED lights up.	The Tip Holder ⑮ is used with UNCLAMP mode (  ).	Change the setting to CLAMP mode (  ).
		The tip holder does not match with the length of the tool.	Adjust the tool length.
Not vibrate when using the Foot Switch ③ .	ON LED not light up GREEN.	The plug of Foot Switch is not connected properly.	Connect the plug of Foot Switch properly.
		The plug of Handpiece is not connected properly to the Receptacle for Connecting Handpiece ⑩ .	Re-connect the plug of Handpiece correctly.
		The Foot Switch ③ is defective.	Return to a NAKANISHI dealer for service.
		The output cord is broken.	
	The ultrasonic oscillator or the Control Unit ① is broken.		
ON LED or the RESET LED lights up.	The ultrasonic oscillator or the Control Unit ① is defective.		





※仕様及び形状等は予告なく変更する場合がありますので、ご了承ください。

※Specifications may be changed without notice.

株式会社 **ナカニシ** [www.nakanishi-inc.com](http://www.nakanishi-inc.com)

本社・工場

〒322-8666 栃木県鹿沼市下日向 700  
TEL: 0289(64)3380 FAX: 0289(62)5636

東京事務所

〒110-0015 東京都台東区東上野 4-8-1 TIXTOWER UENO 9F  
TEL: 03(5828)7740 FAX: 03(5828)0064

**NAKANISHI INC.**  [www.nakanishi-inc.com](http://www.nakanishi-inc.com)  
700 Shimohinata Kanuma-shi Tochigi 322-8666, Japan

**NSK Europe GmbH**  [www.nsk-europe.de](http://www.nsk-europe.de)  
Elly-Beinhorn-Strasse 8 65760 Eschborn, Germany

**NSK America Corp** [www.nskamericacorp.com](http://www.nskamericacorp.com)  
1800 Global Parkway Hoffman Estates, IL 60192, USA