

CARBIDE CUTTERS

SHANK $\phi 3.0$

12 pcs./pack **Single Cut** Assorted Set



28111 Titanium Coating	
Set (12 pieces) (Each code No. one piece-pack)	
21201	21245
21205	21261
21212	21262
21213	21265
21241	21272
21242	21275

SHANK $\phi 6.0$

8 pcs./pack **Double Cut** Assorted Set



28115 Titanium Coating	
Set (8 pieces) (Each code No. one piece-pack)	
21511	21535
21512	21536
21515	21541
21516	21546

SHANK $\phi 3.0$

12 pcs./pack **Single Cut** Assorted Set



28141	
Set (12 pieces) (Each code No. one piece-pack)	
24016	24301
24019	24303
24041	24305
24044	24402
24161	24452
24164	24454

12 pcs./pack **Double Cut** Assorted Set



28145	
Set (12 pieces) (Each code No. one piece-pack)	
24073	24362
24076	24364
24093	24366
24096	24504
24214	24532
24217	24534

SHANK $\phi 6.0$

8 pcs./pack **Single Cut** Assorted Set



28171	
Set (8 pieces) (Each code No. one piece-pack)	
26011	26111
26031	26131
26071	26151
26091	26171

8 pcs./pack **Single Cut** Assorted Set



28175	
Set (8 pieces) (Each code No. one piece-pack)	
26013	26113
26033	26133
26073	26153
26092	26172

SHANK $\phi 6.0$

8 pcs./pack **Double Cut** Assorted Set



28181	
Set (8 pieces) (Each code No. one piece-pack)	
26021	26121
26041	26141
26081	26161
26101	26181

8 pcs./pack **Double Cut** Assorted Set



28185	
Set (8 pieces) (Each code No. one piece-pack)	
26023	26123
26043	26143
26083	26163
26102	26182

SHANK $\phi 3.0$

12 pcs./pack **Alloy Cut** Assorted Set



24601	
Set (12 pieces) (Each code No. one piece-pack)	
24611	24646
24612	24651
24622	24653
24623	24654
24631	24661
24632	24663

* Wood box will be replaced with the plastic case when the stock of wood box is sold out.

SPECIALTY TOOLS



High Speed Steel(H.S.S.)Cutters.
For cutting of general steels,
light metals, non-metals, plastics,
resins, etc.

SHANK $\phi 3.0$

1 pc./pack



1 pc./pack

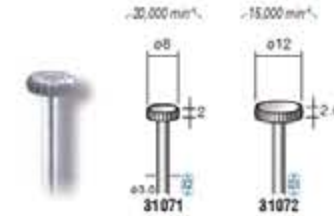

1 pc./pack



Tungsten Vanadium Steel Cutters.
For fine finishing of soft materials,
resins, bronze, acrylics, etc.

SHANK $\phi 2.34$

12 pcs./pack

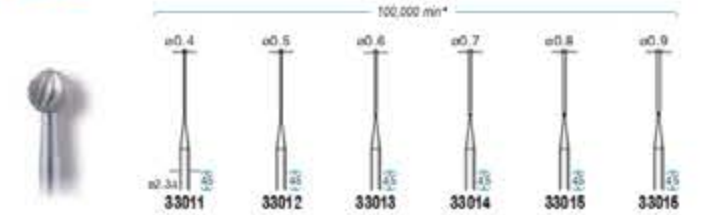

SHANK $\phi 2.34$

12 pcs./pack

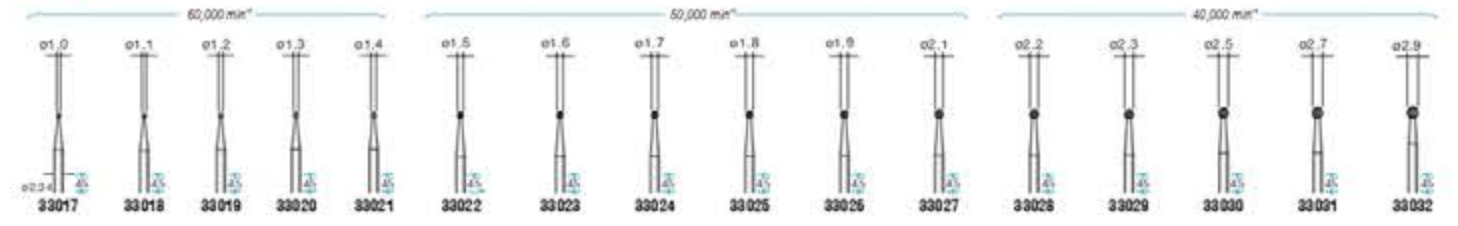

SHANK $\phi 2.34$

12 pcs./pack

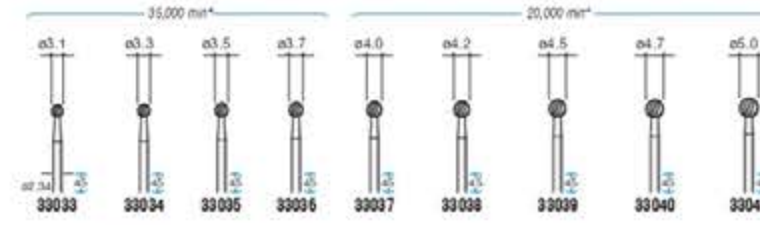

SHANK $\phi 2.34$

12 pcs./pack



SPECIALTY TOOLS

SHANK 2.34
12 pc./pack

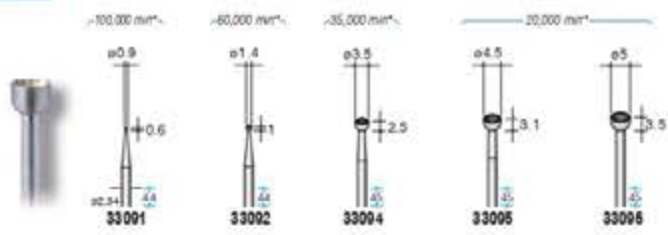

12 pc./pack Tapered Type

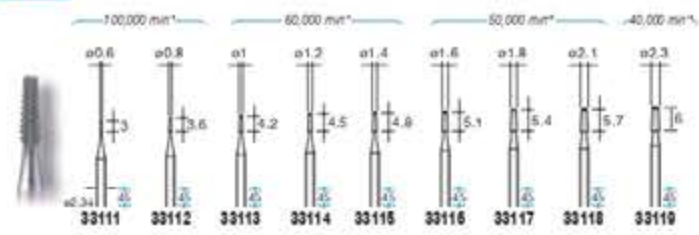

SHANK 2.34
12 pc./pack Straight Type

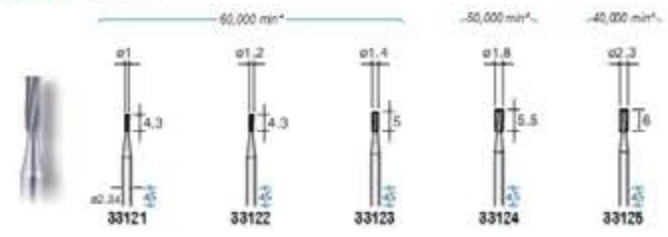

12 pc./pack

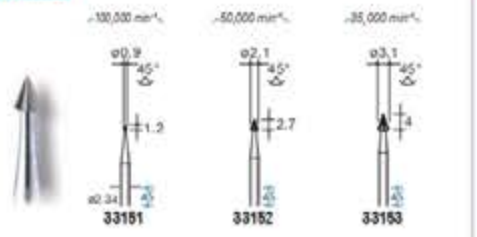

6 pc./pack



SHANK 2.34
12 pc./pack

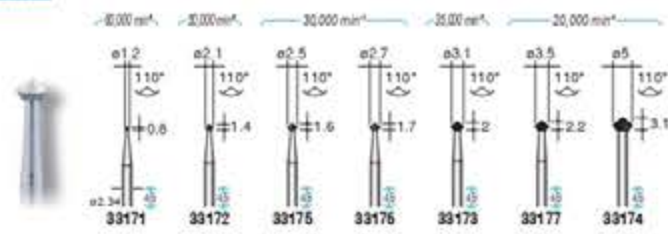

12 pc./pack

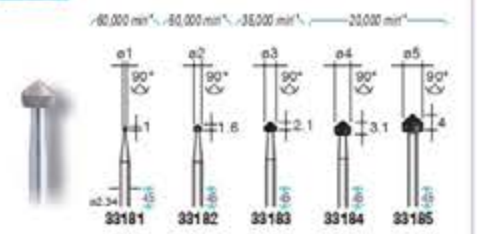

1 pc./pack



SHANK 2.34
12 pc./pack

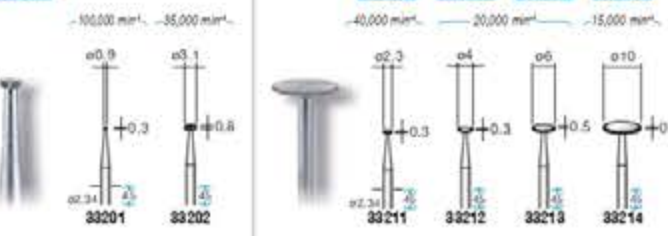

10 pc./pack Saw Blade

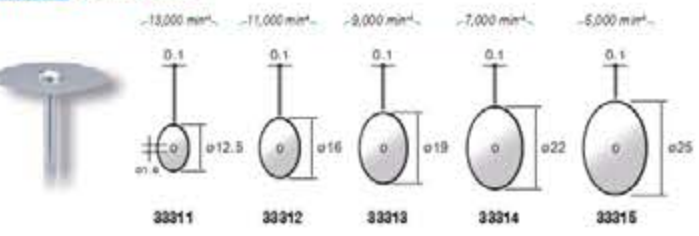

SHANK 2.34
6 pc./pack



6 pc./pack



6 pc./pack



6 pc./pack

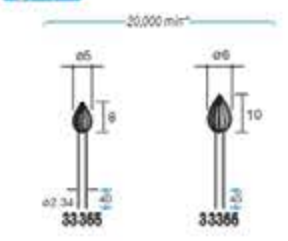

SHANK 2.34
6 pc./pack

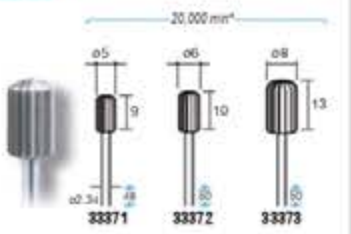

6 pc./pack



6 pc./pack



SHANK 3.0
6 pc./pack

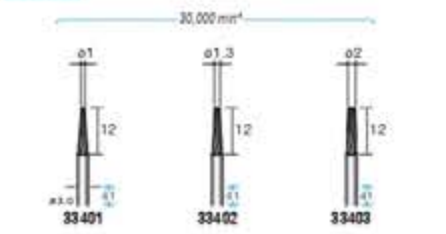

*Cutting for plastic and acryl.

SPECIALTY TOOLS



Tempered Steel Drills for plastics and woods. High Speed Steel Drills for steels and stainless steels, Carbide Drills for PCB, FRP.

SHANK 2.34
12 pc./pack

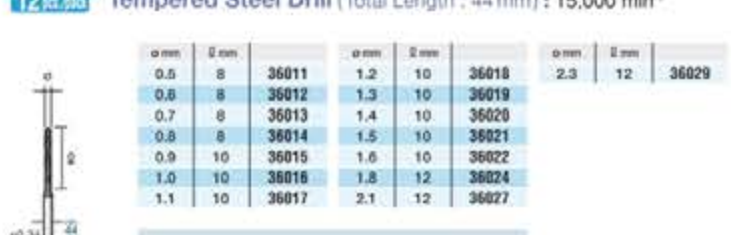

Tempered Steel Drill (Total Length : 44 mm) : 15,000 min⁻¹

φ mm	ℓ mm		φ mm	ℓ mm		φ mm	ℓ mm	
0.5	8	36011	1.2	10	36018	2.3	12	36029
0.6	8	36012	1.3	10	36019			
0.7	8	36013	1.4	10	36020			
0.8	8	36014	1.5	10	36021			
0.9	10	36015	1.6	10	36022			
1.0	10	36016	1.8	12	36024			
1.1	10	36017	2.1	12	36027			

•φ0.5~2.3 mm each 1 pc. Full Size Set (No. 36011 ~ 36029 ; 15 pcs. - pack) ; Special case provided 36030

SHANK 2.34
10 pc./pack

High Speed Steel (H.S.) Drill (Total Length : 44 mm) : 20,000 min⁻¹



φ mm	ℓ mm		φ mm	ℓ mm		φ mm	ℓ mm	
0.5	9	36051	1.2	11	36058	1.9	12	36065
0.6	9	36052	1.3	11	36059	2.0	12	36066
0.7	9	36053	1.4	11	36060	2.1	12	36067
0.8	11	36054	1.5	12	36061	2.2	12	36068
0.9	11	36055	1.6	12	36062	2.3	12	36069
1.0	11	36056	1.7	12	36063			
1.1	11	36057	1.8	12	36064			

•φ0.5~2.3 mm each 1 pc. Full Size Set (No. 36051 ~ 36069 ; 19 pcs. - pack) ; Special case provided 36070

SPECIALTY TOOLS

SHANK $\phi 2.34$
10 pcs./pack Mandrels



SHANK $\phi 3.0$
10 pcs./pack Mandrels 3 pcs./pack Mandrels

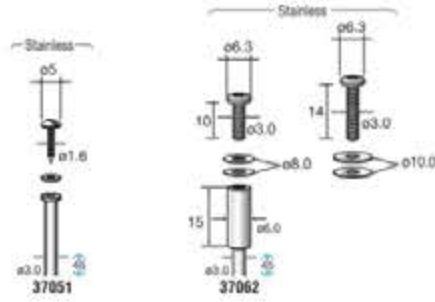

SHANK $\phi 6.0$
1 pc./pack Mandrels



SHANK $\phi 2.34, \phi 3.0$
10 pcs./pack

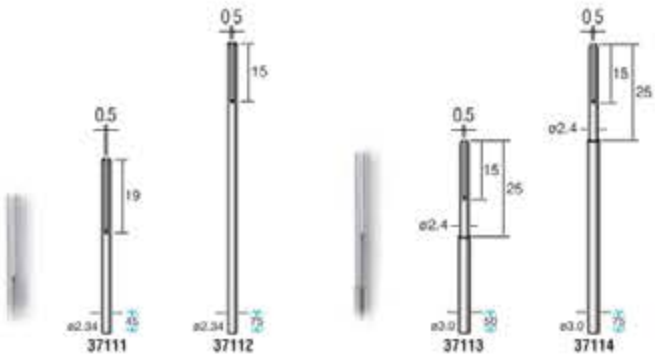

MOUNTED POINTS

Types of Abrasive Grain

"Abrasive Grain" is a general term of very hard abrasive particles for polishing and grinding. Abrasive Grain is harder than work materials and functions to grind work materials. Abrasive Grain is classified generally into three types.

Alumina type

Primary ingredient is alumina (aluminium oxide : Al_2O_3).

- A** : For rough grinding of iron and steel materials, low carbon steels, forged products, castings and raw steel materials.
- WA** : For general grinding of alloy steels, tool steels and carbon steels.
- PA** : For general grinding of heat treated alloy steels, tool steels, and stainless steels.

Silicon Carbide type

Primary ingredient is silicon carbide (SiC).

- C** : For general grinding of cast iron, chilled cast iron, copper, bronze, brass, aluminum and non ferrous metals.
- GC** : For general grinding of super hard alloys, ceramics, stone, jewelry, glass, pottery, wood and synthetic resins.

Mixed Abrasive Grain type

Mixed use of abrasive grain of the same type

- PA · W** : For precision grinding of high speed steel, alloy steels, tool steels and special alloys.
- A · WA** : For rough grinding of iron and steel materials, low carbon steels, forged products, castings, steel materials and stainless steels.

Bonding Material

Material used to bond and hold abrasive grains. Primary bonding materials are shown below.

- V** (vitrified) : Mainstream of magnetic bonding material, grinding stone
- B** (resinoid) : Bonding material is mainly made of thermosetting
- R** (rubber) : Hard rubber
- E** (shellac) : Thermoplastic resin (natural resin)

Hardness Grade

This shows bonding strength of abrasive grain, bonding materials and wear resistance of grinding stone. The Hardness Grade is measured by various instruments. The hardness is classified from A to Z, A is the softest while Z is the hardest.

Hardness Grade

E	F	G	H	I	J	K	L	M	N	O	P	Q	R	S	T	~	Z
← Very soft		← Soft		← Medium		← Hard		← Very Hard									



1.6 mm shank diameter series. Short Shank Type grindstones for high-speed rotation. Ideal for very small parts.

SHANK $\phi 1.6$
10 pcs./pack

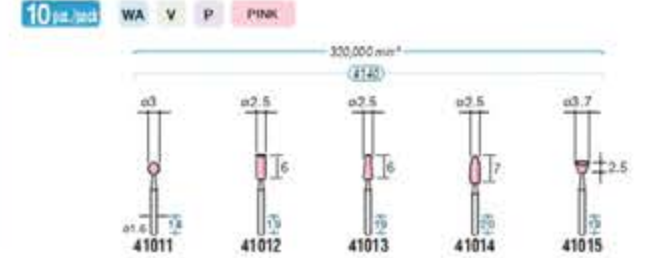

SHANK $\phi 1.6$
10 pcs./pack

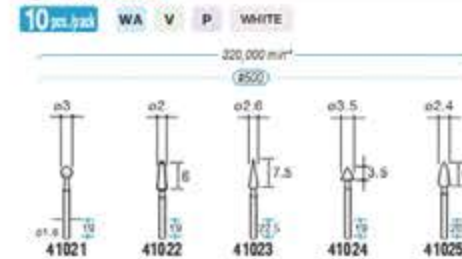

SHANK $\phi 2.34$
10 pcs./pack

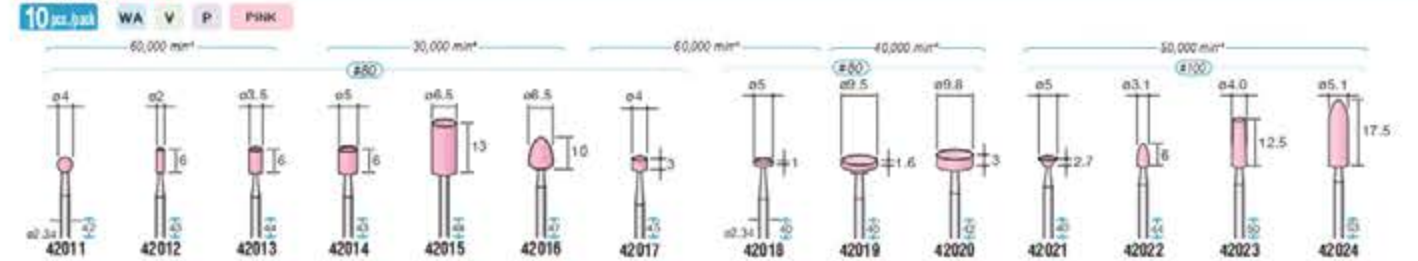

SHANK $\phi 2.34$
10 pcs./pack

